

GPS/WAAS COLOR CHART PLOTTER with Echo Sounder  
Model **GP-3700/3700F**

**SPECIFICATIONS**

<b>1. DISPLAY UNIT</b>	
Display	12.1-inch IPS color LCD, 246 x 184.5 mm
Display resolution	600 (H) x 800 (V), SVGA
Usable area	85° latitude or below
Display mode	Plotter, Compass, Satellite information, Fish finder* *GP-3700F only
<b>2. GPS/ SBAS (WAAS/EGNOS/MSAS) RECEIVER</b>	
Receiving channels	GPS: 12 channels, 12 satellites, parallel tracking
Rx frequency	SBAS: 2 channels
Rx code	GPS: 1575.42 MHz
Position accuracy	GPS: not exceeding 10 m, (2drms, HDOP≤4) DGPS: not exceeding 5 m, (2 drms) optional kit required SBAS: not exceeding 7 m, (2 drms)
Position-fixing time	90 s approx.
Position update interval	1 s
<b>3. PLOTTER</b>	
Effective projection area	0.025 to 1,024 NM (at equatorial area)
Memory capacity	990,000 points (recording memory 1 block + storage 10 block) <b>Memory capacity per one memory block</b> <b>Maximum display points</b> Own ship's track: 30,000 pts 3,000 pts Mark/line: 30,000 pts 3,000 pts Other ship's track -TT: 10,000 pts 1,000 pts -AIS: 10,000 pts 1,000 pts -GPS buoy: 10,000 pts 1,000 pts Waypoint Route Cartography 3,500 points with comment (GP 35 points) 200 routes and 1 simple route with 100 waypoints each MapMedia Vector Chart
<b>4. SOUNDER (for GP-3700F only)</b>	
Transmit frequency	50/200 kHz
Output power	600 W or 1 kW
Display range	Range: 5 to 1,200 m, Shift: 0 to 1,200 m
Extension mode	Marker zoom, Bottom zoom, Bottom lock, Bottom discrimination
Picture advance	6 steps
<b>5. INTERFACE</b>	
Number of ports	
IEC61162-1 (NMEA)	3 ports, NMEA0183 V1.5/2.0/3.0/4.1, 4800/38400 bps
LAN	1 port, Ethernet 100base-TX
USB	2 ports, USB2.0, Type-A (for control unit connection/ maintenance)
NMEA2000	1 port
External speaker	1 port, 5W/4 ohm
External video output	1 port, Analog VGA
Contact closure	BK: 1 port, Event switch: 2 ports
Data Sentense	
Input	ALR, BLV, CRQ, CUR, DBK, DBS, DBT, DPT, GGA, GLL, GNS, HDG, HDM, HDT, MSK, MTW, MWV, RMA, RMB, RMC, TLL, TTM, VDM, VHW, VTG, VWR, VWT, THS, VDR, ZDA
Output	AAM, APB, BOD, BWC/BWR, DBT/DPT, DTM, GGA, GLL, GNS, GSA, GSV, GTD, HDG, HDT, MSK, MSS, MTW, MWV, RMA, RMB, RMC, RTE, THS, TLL, TTM, VHW, VTG, WPL, XTE, ZDA
NMEA2000 PGN	
Input	059392/904, 060928, 126208/464/996, 127237/250, 129538/539, 130577
Output	059392/904, 060928, 126208/464/992/993/996, 127258, 128267/275, 129025/026/029/033/283/284/285/538/539
<b>6. ENVIRONMENTAL CONDITIONS</b>	
Ambient temperature	
Antenna unit	-25°C to +70°C
Display unit	-15°C to +55°C
Degree of protection	
Antenna unit	IP56
Display unit	IP22
<b>7. POWER SUPPLY</b>	
	12-24 VDC
GP-3700	2.5-1.3 A
GP-3700F	2.8-1.5A

**EQUIPMENT LIST**

<b>1. Standard</b>		
1. Display Unit GP-3700/3700F	1 unit	
2. Antenna Unit GP-020S	1 unit	
3. Antenna Cable 15m	1 pc	
4. Installation Materials and Standard Spare parts	1 set	
<b>2. Options</b>		
1. TrackBall Control Unit RCU-030	9. Power BOX	
2. Internal DGPS Beacon receiver kit OP14-80	10. Rectifier RU-3423	
3. Display flushmount, F/Flushmount OP14-83	11. Speed/Water temperature ST-02MSB, ST-02PSB	
4. Antenna cable assembly 30/40/50 m	12. Temperature sensor ST-04MSB	
5. Joint box TL-CAT-L12	13. Innerhull kit 22S0191	
6. LAN cable assembly	14. Antenna mounting base	
7. Cable assembly	15. Mast mounting bracket CP20-01111	
8. MJ cable assembly		
MJ-MJ-A3SPF0013-035C (5A)		
<b>3. Transducer and Triducer options</b>		
<b>600 W</b>		
520-5PSD (Plastic thru-hull), 520-5MSD (Bronze thru-hull), 520-5PWD (Plastic transom)		
525ST-MSD (Bronze thru-hull w/speed/temp sensor), 525ST-PWD (Plastic transom speed/temp sensor)		
520-PLD, 525T-BSD, 525T-PWD, 525T-LTD/12, 525T-LTD/20, SS60-SLTD/12, SS60-SLTD/20		
<b>1 kW (Optional matching box MB-1000 required)</b>		
50B-6, 50B-6B, 200B-5S, 50/200-1T, 526TID-HDD		

**DISPLAY UNIT**

<b>GP-3700</b>	<b>GP-3700F</b>
4.6 kg 10.1lb	4.8 kg 10.6lb

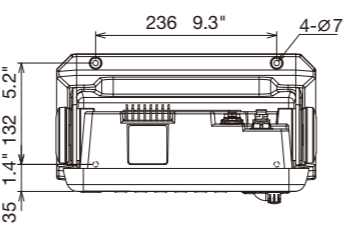
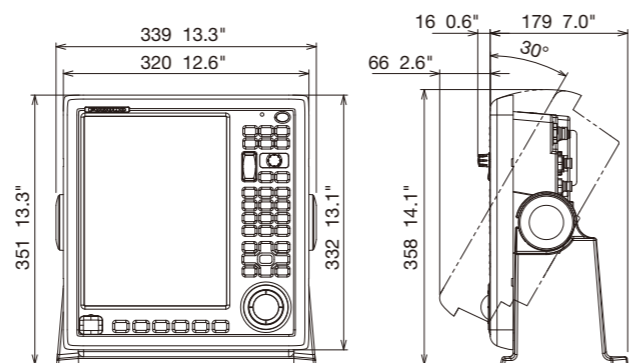

**Antenna Unit**

<b>GPA-020S (for GPS)</b>	0.32 kg 0.71 lb
<b>GPA-021S (for DGPS)</b>	0.52 kg 1.15 lb

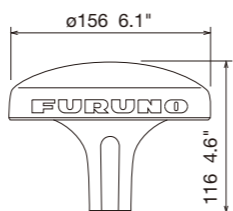

**GPS/WAAS COLOR CHART PLOTTER**

Model

**GP-3700/3700F**

Fish Finder integrated

*Easy to Use,  
Fully Featured Plotter*



Beware of similar products

All brand and product names are registered trademarks, trademarks or service marks of their respective holders.

SPECIFICATIONS SUBJECT TO CHANGE WITHOUT NOTICE

**FURUNO ELECTRIC CO., LTD.**  
Japan | www.furuno.com  
**FURUNO U.S.A., INC.**  
U.S.A. | www.furunousa.com  
**FURUNO PANAMA S.A.**  
Republic of Panama | www.furuno.com.pa  
**FURUNO (UK) LIMITED**  
U.K. | www.furuno.co.uk  
**FURUNO NORGE A/S**  
Norway | www.furuno.no

**FURUNO DANMARK A/S**  
Denmark | www.furuno.dk  
**FURUNO SVERIGE AB**  
Sweden | www.furuno.se  
**FURUNO FINLAND OY**  
Finland | www.furuno.fi  
**FURUNO POLSKA Sp. Z o.o.**  
Poland | www.furuno.pl  
**FURUNO DEUTSCHLAND GmbH**  
Germany | www.furuno.de

**FURUNO FRANCE S.A.S.**  
France | www.furuno.fr  
**FURUNO ESPAÑA S.A.**  
Spain | www.furuno.es  
**FURUNO ITALIA S.R.L.**  
Italy | www.furuno.it  
**FURUNO HELLAS S.A.**  
Greece | www.furuno.gr  
**FURUNO (CYPRUS) LTD**  
Cyprus | www.furuno.com.cy

**FURUNO EURUS LLC**  
Russian Federation | www.furuno.ru  
**FURUNO SHANGHAI CO., LTD.**  
China | www.furuno.com/cn  
**FURUNO CHINA CO., LTD.**  
Hong Kong | www.furuno.com/cn  
**FURUNO SINGAPORE**  
Singapore | www.furuno.sg  
**PT FURUNO ELECTRIC INDONESIA**  
Indonesia | www.furuno.id

**FURUNO ELECTRIC (MALAYSIA) SDN. BHD.**  
Malaysia | www.furuno.my



\*GP-3700F

1-B-1811PDF  
Catalogue No. CA000001290

www.furuno.com

# Smart Features for Effortless, Faster, and More Intuitive Usage

The GP-3700 is the new high performance color GPS/WAAS Chart Plotter and the GP-3700F is our GPS/WAAS Chart Plotter/Echo Sounder combination unit. Both incorporate the easy-to-use interface from the GP-3500, while adding new enhancements and features. With a variety of innovative functions, short-cut control keys and a 12.1-inch IPS screen that provides clear visibility, the GP-3700 series lets you immediately grasp a situation surrounding your vessel. Large storage capacity for track points, buoy points and marks/lines makes it a perfect solution for long term fishing operations.



## 1 User customizable keys

User customizable keys allow you to create short-cuts to menus. Customize menus before you leave the dock for faster, effortless and more intuitive operation. A screen shot function allows you to look back at past data and status when you return from your trip.

## 2 12.1 inch large display

The larger IPS LCD screen, which features a distinctively clear and wider viewing angle, gives you excellent readability.

## 3 Huge storage capacity

The GP-3700 series is capable of storing up to: 30,000 own ship track points, 10,000 TT/AIS/consort/GPS buoy points, 30,000 mark/lines, and can record way points and routes.

## 4 A variety of display modes

The GP-3700 series provides and displays navigation data in a wide variety of modes. All the display modes can be switched by tapping "DISP" key. Plotter, Compass, Satellite information and Fish Finder\* are able to be chosen and customized as you like.

\*Compared to GP-3500/3500F

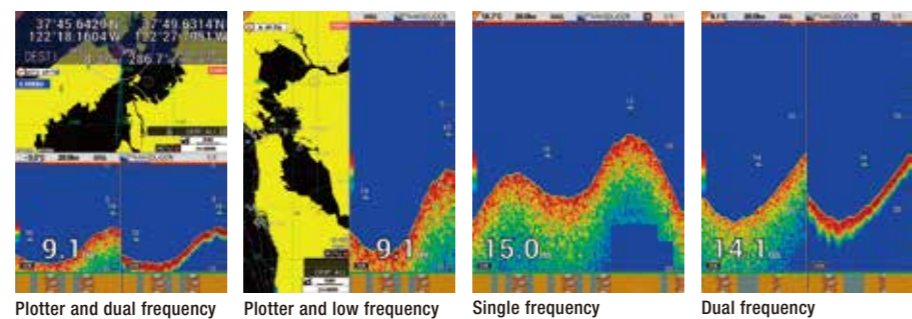

## 5 UNDO/REDO functions

The "UNDO" key lets you go back one operational step of deleting and drafting your marks and lines with a single press of a key. While the "UNDO" key works as going back your operation, the "REDO" function recovers your last operation. The "REDO" function can be set from the direct function key menu.

## 6 Easy-access USB port

USB flash drive (local supply) can be connected to the front panel. Stored data can be used for retrofit, review for the service, and record of your navigation marks.

### Mark keys

Colorful keys to mark lines and points on the display

### Trackball

can be used to quickly move the cursor, while arrow keys can be used for more precise cursor manipulation.

## A variety of orientation modes

The GP-3700 series has Head Up, North Up, Auto Course Up, Course Up, Go To Up, and Specified Direction Up display modes. Specified Direction Up mode is a target-oriented navigation map, allowing the map to remain vertical in the direction of the target. You can choose the desired display mode to suit operational needs.

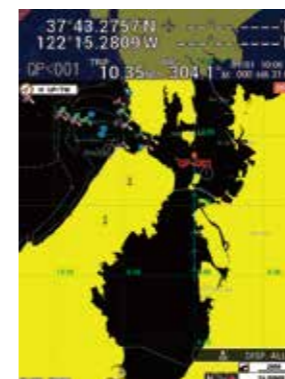

Head Up mode

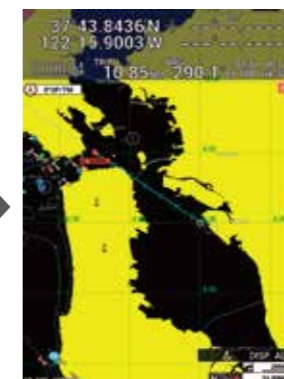

Specified Direction Up mode

## Scroll-Back \*for GP-3700F

By scrolling back the history on the Fish Finder screen, you can find the fishing ground/fish targets again and drop a mark, so that you can plot a course back to that area.



## ACCU-FISH™ and Bottom Discrimination System \* for GP-3700F

### Single frequency mode

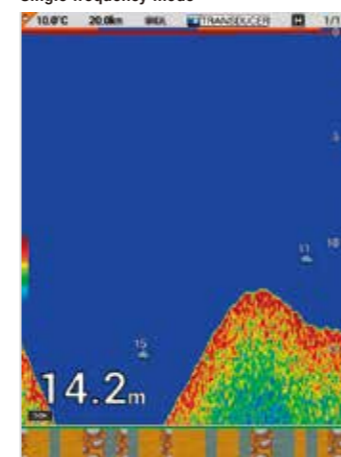

Graphic mode  
 Rocks Gravel Sand Mud

### Dual frequency mode

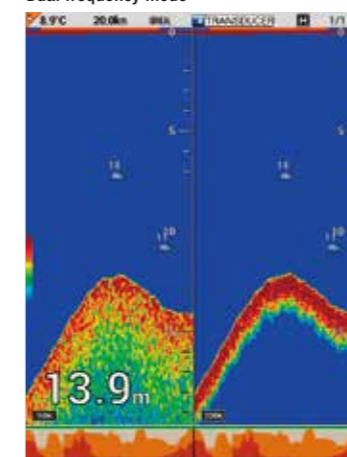

Probability mode  
 Rocks Gravel Sand Mud



### ACCU-FISH

Individual fish size is calculated from echo strength. ACCU-FISH™ can detect fish sizes of 10 to 199 cm, at depths of 2 to 100 m.



### Bottom Discrimination System

Bottom Discrimination feature enables the fish finder to indicate if a major component of the seabed is detected in rocks, gravel, sand or mud.

#### \*Notes:

- Use at a depth of 5 m – 100 m.
- Use transducer in transom mount or thru-hull mount.
- To show a consistent display of the actual bottom, set the range display of the fish finder screen to "auto".
- Enter the ship's draft value.
- Use a ship speed of 10 kn or less.
- In some instances, bottom component indicated on the display may differ from its actual bottom structure.

## INTERCONNECTION DIAGRAM

— Standard supply  
 — Optional or local supply

- \*1: Use when the display unit has no beacon receiver.
- \*2: Use when the internal beacon receiver is installed to the display unit.
- \*3: Required for 1 kW transducer (50B-6, 50B-6B, 200B-5S, 50/200-1T). Only for GP-3700F
- \*4: Only for GP-3700F
- \*5: Only one GP-3700F or GP-3700 can be connected when you are using a NAVpilot-700 series.

