

FURUNO

RADAR

Model: FAR-23x8 series

Keep Steady At Sea

with the safe, reliable and user-friendly next generation Radar



 **Mackay**
Marine Electronics &
Satellite Communications
www.mackaymarine.com

www.furuno.com

Keep Steady At Sea

with the safe, reliable and user-friendly next generation Radar



RADAR

FAR-23x8 series

for Category 1 of ship/craft, with 27" wide or 23" LCD

FAR-2318	X-band, 12 kW, TR up
FAR-2328	X-band, 25 kW, TR up
FAR-2328W	X-band, 25 kW, TR down
FAR-2328-NXT	X-band, 600 W, TR up, Solid State
FAR-2338S	S-band, 30 kW, TR up
FAR-2338SW	S-band, 30 kW, TR down
FAR-2338S-NXT	S-band, 250 W, TR up, Solid State

Complies with the following regulations:

IEC 62388 Ed.2.0	IEC 61162-1 Ed.5.0
IEC 62288 Ed.2.0	IEC 60945 Ed.4.0
IEC 61162-2	IEC 61162-450

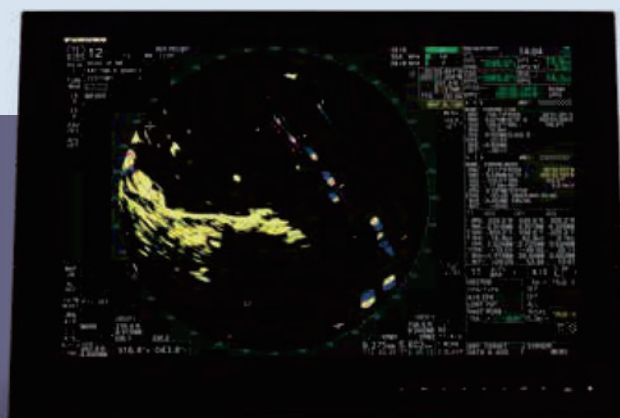

Advanced technologies for navigation safety

The Furuno FAR-23x8 series is a brand-new Radar series characterized by its state-of-the-art antenna design and innovative signal processing technologies. Furuno's latest, advanced technologies and intuitive design will increase situational awareness, facilitating unparalleled navigational safety.

► Automatic Clutter Elimination (ACE) for unprecedented echo clarity

Quickly adjusts the Radar image with a single button press. When the ACE function is activated, the system automatically optimizes clutter reduction filters and gain control according to the sea and weather conditions.

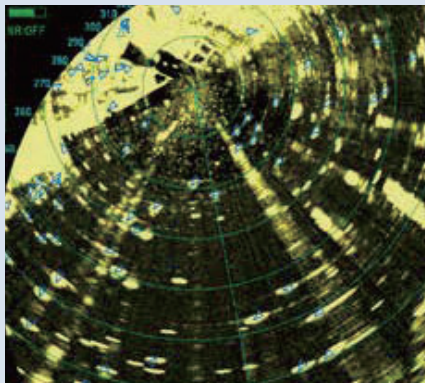

ACE OFF

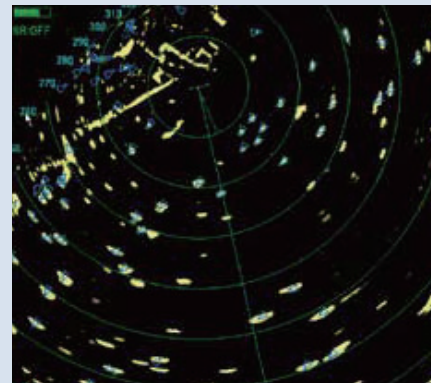

ACE ON

► Fast Target Tracking™ function provides early-stage collision avoidance

With Fast Target Tracking™, the FAR-23x8 series provides accurate tracking information; speed and course vectors are displayed in mere seconds allowing operators to take action and avoid incidents at a very early stage.

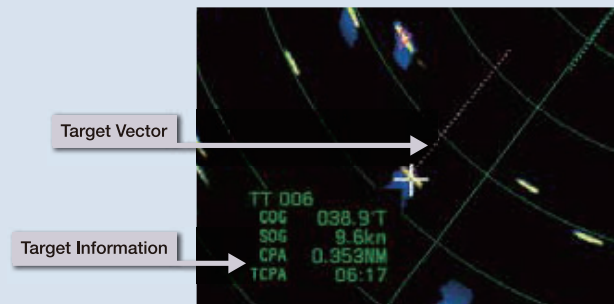

Solid State Radar model - NXT - specializes in target detection and maintainability

Compared to the traditional Magnetron Radar, the Solid State Radar NXT Series provide highly reliable target detection while requiring low power.

► Clear images

Furuno Solid State Radar technology generates clear echo images, which allows users to obtain a clear picture of the area around their vessel, including weaker echoes from small crafts.

► Reducing the time and cost for maintenance

- No need to replace the magnetron
- Removal of the consumable parts thanks to a fan-less antenna (S-band only)

Power Amplifier Module of the Solid State transceiver

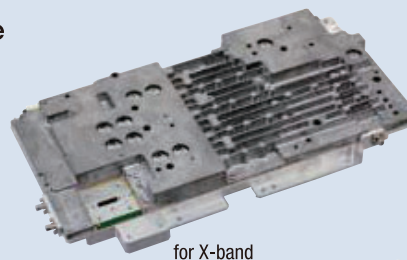

for X-band



for S-band



Exceptionally intuitive user interface

InstantAccess bar™

▶ **InstantAccess bar™** for quick access to your frequently used functions
 InstantAccess bar™ contains shortcut menus for frequently used functions and actions, allowing for quick access to essential tasks.

Radar function menu

- TX STBY
- PULSE L
- TUNE MAN
- IR 3
- ES 3
- EAV OFF
- ACE OFF

Display setting menu

- MAP ON
- HL OFF
- CU/TH RESET
- OWN AIS
- AIS PLT1
- 100

Screen image: Wide monitor MU-270W

▶ Well-designed controllers for stress-free operation

Comfortable usability is very important on long voyages. With that in mind, these control units are designed based on ergonomics to comfortably accommodate the operator's hand. All operations can be controlled with the trackball.

Control Unit

Trackball Control Unit

- EBL controls
- User Customizable Function Keys

- VRM controls
- Menu Item Selector (wheel and enter keys)
- Cursor Control

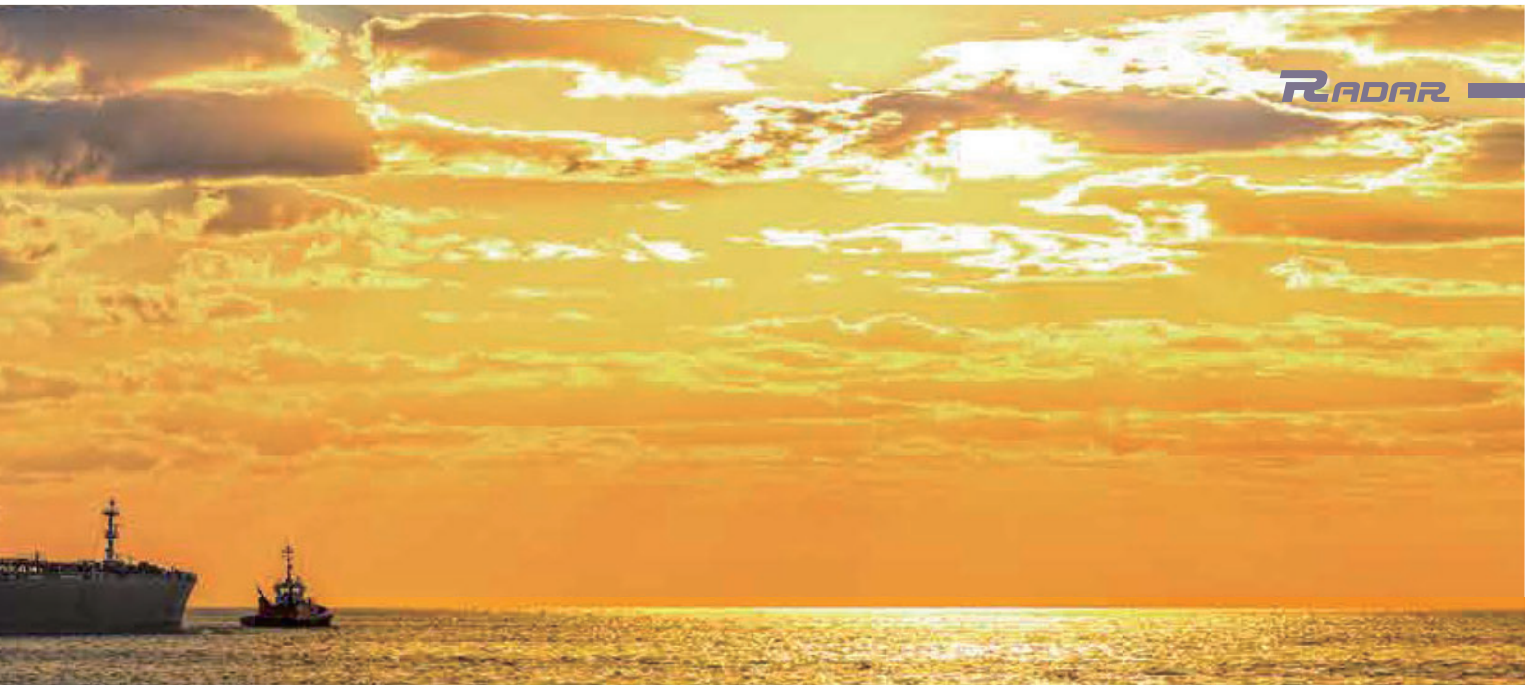

Refined antenna with excellent reliability and easy maintenance



The FAR-23x8 series is designed to provide clearer and more accurate Radar images of the surroundings, while increasing reliability and decreasing overall cost of ownership with easy maintenance.

Signals are safely transported through the Ethernet network between the antenna and below deck processing unit, allowing for higher reliability. High quality images are obtained by the signal processor inside the antenna unit, directly converting analog to digital signals before sending them to the main processor unit.

The new antenna's refined shape significantly reduces aerodynamic drag and lightens the burden on the gear box. The gear box itself has also been redesigned. Decreased aerodynamic drag and a DC brushless motor result in a very durable gear box that can be used for a prolonged period of time.

Installation and maintenance are now easier than ever. All components of the gear box are integrated into one block that can easily be removed from the gear box when maintenance is required. The cable to the gear box can be connected from the side of the gear box.

Easy installation for new building as well as retrofits, with high flexibility

▶ **27" wide monitor (model: MU-270W) selectable.**

With the expanded wide monitor, 9 TT data boxes will be displayed on the screen. The color contrast of the display is excellent so that Radar echo can be grasped at a glance.

▶ **Existing monitor, control unit and cables can be used in retrofitting*.**

*Only when retrofitting in lieu of FAR-2xx7 series

▶ **Optional LAN Signal Converter enables Ethernet communication. Extension of the cable between antenna unit and processor unit utilizing existing cables when retrofitting is possible.**

▶ **Ethernet connectivity with onboard system**

Ethernet expands the radar's capability with connection between either existing or newly installed systems, such as ECDIS and VDR.

▶ **With the optional Ethernet HUB, Inter-switch can be utilized.**

▶ **DVI-I cable is connectible to VDR in retrofitting.**

How to connect VDR with FAR-23x8 series

VR-7000/7000S	Directly connect VDR with LAN or convert the RGB signal from a DVI-I port using video LAN converter, and input to the VDR.
VR-3000/3000S	Directly input the RGB signal from a DVI-I port to the VDR.
Other manufacturer's VDR	Please check with the VDR manufacturer to connect appropriately.

Advanced technologies for safer and optimal navigation in all kinds of situations (option)

▶ **Wave Analyzer Software ***

- Allows real-time monitoring and analysis of wave echoes
- Ensures safety at sea even at night

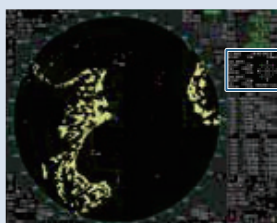

*More details on the Wave Analyzer brochure

▶ **Ice Mode ** (X-band magnetron only)**

- Find the best route through ice
- Observe ice conditions by Radar

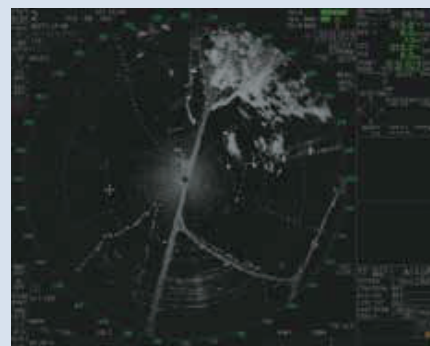

**Please contact your local distributor for more details

Product Name MARINE RADAR



Antenna Radiator

- 1. Type** Slotted waveguide array
2. Beam width and sidelobe attenuation

Radiator type	X-Band			S-Band
	XN12CF	XN20CF	XN24CF	SN36CF
Length	4 ft	6.5 ft	8 ft	12 ft
Horizontal beam width	1.9°	1.23°	0.95°	1.8°
Vertical beam width	20°	20°	20°	25°
Sidelobe within ±10°	-24 dB	-28 dB	-28 dB	-24 dB
Sidelobe outside ±10°	-30 dB	-32 dB	-32 dB	-30 dB

- 3. Polarization** Horizontal
4. Rotation 24 rpm or 42 rpm (for high speed craft)
*XN24CF not available in 42 rpm
100 kn relative
5. Wind load
6. De-icer (option) On: when temperature goes down to 0°C
Off: when temperature goes up to +5°C

Transceiver

1. TX Frequency and modulation

X-band (Magnetron)	9410 MHz ±30 MHz, P0N
S-band (Magnetron)	3050 MHz ±30 MHz, P0N
X-band (Solid state)	CH1 P0N: 9403.75 MHz/Q0N: 9423.75 ±5MHz or CH2 P0N: 9413.75 MHz/Q0N: 9433.75 ±5MHz
S-band (Solid state)	CH1 P0N: 3043.75 MHz/ Q0N: 3063.75 MHz ±5 MHz or CH2 P0N: 3053.75 MHz/ Q0N: 3073.75 MHz ±5 MHz

2. Output power

FAR-2318	12 kW
FAR-2328/2328W	25 kW
FAR-2328-NXT	600 W
FAR-2338S/2338SW	30 kW
FAR-2338S-NXT	250 W

3. Range scale, Pulse Repetition Rate and Pulse length

Magnetron radar: FAR-2318/2328/2328W/2338S/2338SW

PRR (Hz approx.)	Range scale (NM)											
	0.125	0.25	0.5	0.75	1.5	3	6	12	24	48	96	
3000	S1											
3000	S2											
1500	M1											
1200					M2							
1000				M3								
600*	L											

*: 500 Hz on 96 NM range.

Solid state radar: FAR-2328-NXT

PRR (Hz approx.)	Range scale (NM)											
	0.125	0.25	0.5	0.75	1.5	3	6	12	24	48	96	
1500	S1											
1500	S2											
1200	M1											
1000					M2							
1000				M3								
600	L											

Solid state radar: FAR-2338S-NXT

PRR (Hz approx.)	Range scale (NM)											
	0.125	0.25	0.5	0.75	1.5	3	6	12	24	48	96	
2400	S1											
2000	S2											
1500	M1											
1060					M2							
1000				M3								
600	L											

Processor Unit

- 1. Minimum range** 22 m
2. Range discrimination 26 m
3. Range accuracy
1% of the maximum range of the scale in use or 10 m, whichever is the greater
4. Bearing discrimination
2.1° (XN12CF), 1.5° (XN20CF), 1.2° (XN24CF), 2.0° (SN36CF)
5. Bearing accuracy ±1°
6. Range scale and Range ring interval (RI)

Range (NM)	0.125	0.25	0.5	0.75	1.5	3	6	12	24	48	96
RI (NM)	0.025	0.05	0.1	0.25	0.25	0.5	1	2	4	8	16
Number of rings	5	5	5	3	6	6	6	6	6	6	6

- 7. Warm-up time** 3 min. approx. (solid state radar excluded)
8. Presentation mode
Head-up, STAB head-up, Course-up, North-up (RM/TM), Stern-up
9. Marks
Cursor, Range ring, Heading mark, North mark, Bearing mark,
Target trail, VRM, EBL, Acquisition zone
10. Target tracking (TT)
Auto or manual acquisition 100 targets in 24/32 NM
(range selected from setting menu)
Tracking 5/10 pts on all targets
Vector time Off, 30 s, 1-60 min
11. AIS
Display capacity 350 targets
Tracking 5/10 pts on activated targets
Vector time Off, 30 s, 1-60 min
12. Radar map 20,000 points
13. Acquisition zone 2 zones
14. Interswitch function Selectable from menu

Display Unit

- 1. Screen type**
MU-231 23.1-inch color LCD, 1600 x 1200 (UXGA)
MU-270W 27-inch color LCD, 1920 x 1200 (WUXGA)
2. Brightness
MU-231/270W 400 cd/m² typical
3. Visible distance
MU-231 1.2 m nominal
MU-270W 1.02 m nominal
4. Radar effective diameter
MU-231 331 mm
MU-270W 349 mm

Interface

- 1. Number of port (processor unit)**
Serial 7 ports (IEC61162-1/2: 2 ports, IEC61162-1: 4 ports, AD-10: 1 port)
Alarm output 6 ports: contact signal, load current 250 mA
(Normal close/ open: 4, System fail: 1, Power fail: 1)
DVI output 2 ports: DVI-D, DVI-I or RGB picture data (VDR)
LAN 2 ports: Ethernet 100Base-TX
RS-232C 1 port: brilliance control
Sub display (for ECDIS) 2 ports: HD, BP, Trigger and Video signal
2. Data sentences (IEC61162-1/2, IEC61162-450)
Input ABK, ACK, ACN, ALR, BWC, BWR, CUR, DBK*, DBS*, DBT,
DDC, DPT, DTM, GGA, GLL, GNS, HBT, HDT*, MTW, MWV,
OSD, RAQ, RMB, RMC, ROT, RTE, THS, VBW, VDM, VDO,
VDR, VHW, VSD, VTG, VWR*, VWT*, WPL, ZDA
Output ABM, ACK, AIQ, ALC, ALF, ALR, ARC, BBM, DDC, EVE, HBT,
OSD, RSD, TLB, TLL, TTD, TTM, VSD
*1: for retrofit.
3. Ethernet interface for IEC61162-450
Port (LAN2) 100Base-TX, IPv4, 8P8C connector
IEC61162-450 transmission group
Input MISC, TGTD, SATD, NAVD, TIME, PROP
Output Arbitrary (default: TGTD)
Multicast address 239.192.0.1 to 239.192.0.16
Destination port 60001 to 60016
Re-transmittable binary image transfer
Multicast address 239.192.0.26 to 239.192.0.30
Destination port 60026 to 60030
Other network function excepted IEC61162-450
SNMP, HTTP, Syslog, Furuno Management Protocol (FMP)
4. Output port on antenna unit
Sub display (for radar) 1 port: HD, BP, Trigger and Video signal

Power Supply

- 1. Processor unit (w/antenna and transceiver unit)**
FAR-2318 100-230 VAC: 2.1-1.0(2.9-1.3)A, 1 phase, 50-60 Hz
FAR-2328/2328W 100-230 VAC: 2.3-1.1(3.2-1.4)A, 1 phase, 50-60 Hz
FAR-2328-NXT 100-230 VAC: 2.1-1.0(2.9-1.3)A, 1 Phase, 50-60 Hz
FAR-2338S/2338SW 100-230 VAC: 3.2-1.5(5.6-2.5)A, 1 phase, 50-60 Hz
FAR-2338S-NXT 100-230 VAC: 2.6-1.2(5.1-2.2)A, 1 phase, 50-60 Hz
(): 42 rpm
2. Display Unit
MU-231 100-230 VAC: 1.0-0.6 A, 1 phase, 50-60 Hz
MU-270W 100-230 VAC: 0.7-0.4 A, 1 phase, 50-60 Hz
3. HUB (option) 100-230 VAC: 0.1 A max, 1 phase, 50/60 Hz
4. De-icer (option) 100-115/220-230 VAC: 2.6/1.3 A, 1 phase, 50-60 Hz

Environmental Conditions

- 1. Ambient temperature**
Antenna unit -25°C to +55°C (storage: -25°C to +70°C)
Indoor units -15°C to +55°C (storage: -20°C to +70°C)
2. Relative humidity 95% or less at +40°C
3. Degree of protection
Antenna unit IP56
Processor/ monitor unit IP22
Control unit IP20
HUB IP20 (HUB-100), IP22 (HUB-3000)
4. Vibration IEC 60945 Ed.4

Equipment List

Standard

- Display Unit MU-231/MU-270W
- Processor Unit RPU-025
- Control Unit RCU-014
Trackball Control Unit (Specify when ordering) RCU-015
- Antenna Radiator XN12CF/XN20CF/XN24CF/SN36CF
- Transceiver RTR-105/106/107/108/109/111
- Gear Box RSB-128/129/130/131/133
- DVI cable (5 m) DVI-D/D S-LINK 5M
- Standard Spare Parts and Installation Materials
- Performance Monitor PM-32A/52A/52B
Option
 - Remote Control Unit RCU-016
 - Junction Box RJB-001
 - AD Converter AD-100-E
 - Switching HUB HUB-100
 - Intelligent HUB HUB-3000
 - De-icer OP03-226/227/231/232
 - LAN Signal Converter
X-band (magnetron) OP03-247-3, X-band (NXT) OP03-247-4,
S-band (magnetron) OP03-247-2, S-band (NXT) OP03-247-1
 - Wave Analyzer Software WV-100/WV-100ST

INTERCONNECTION DIAGRAM

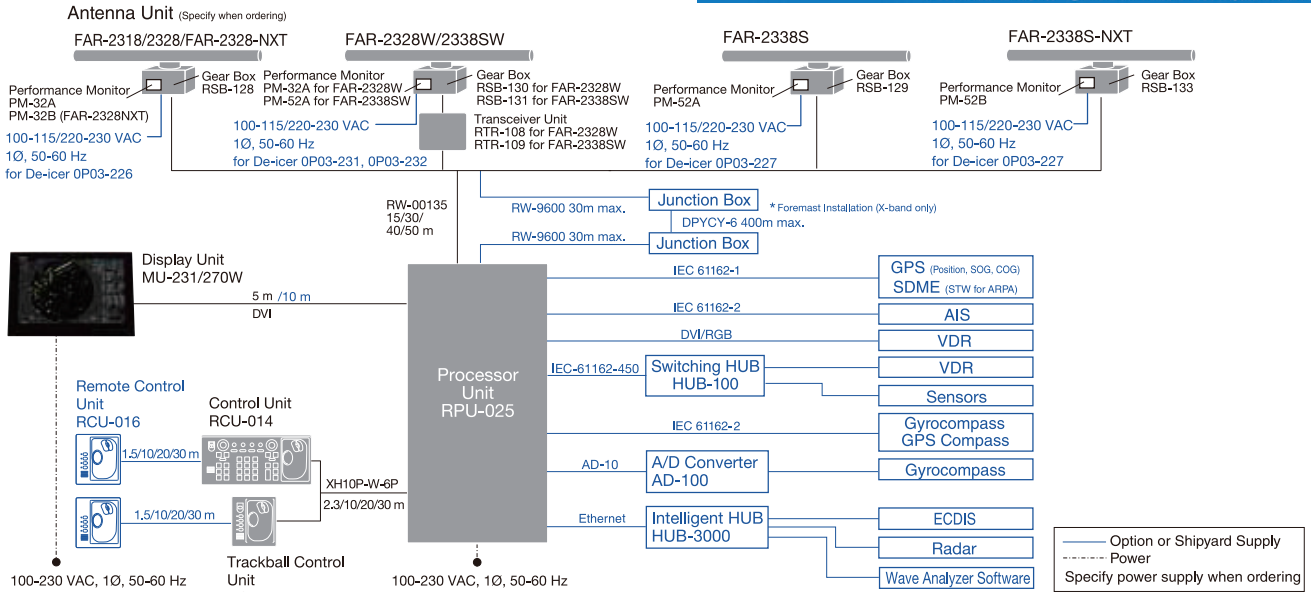

Transceiver Unit for FAR-2328W

RTR-108 17.0 kg 37.5 lb

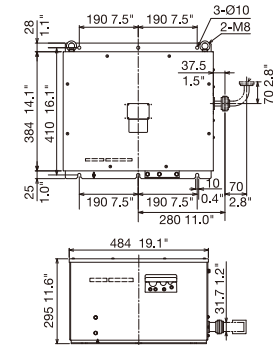

Transceiver Unit for FAR-2338SW

RTR-109 24.0 kg 55.1 lb

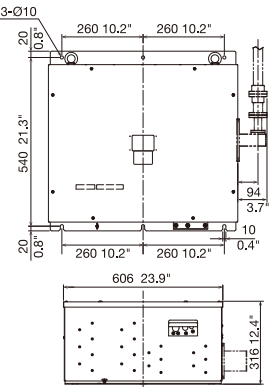

Processor Unit RPU-025

X-band/ S-band 24rpm w/ Fan 9.6 kg 21 lb
S-band 42rpm w/ 2 Fan 11.5 kg 25 lb

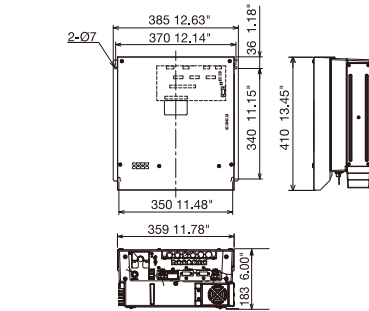

Control Unit RCU-014

2.5 kg 5.5 lb

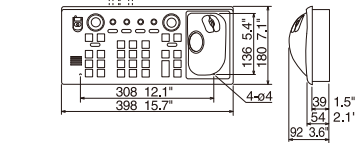

Trackball Control Unit RCU-015

2.4 kg 5.3 lb

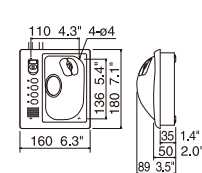

Remote Control Unit RCU-016

2.4 kg 5.3 lb

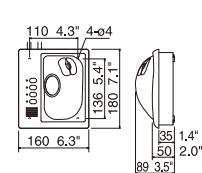

Display Unit MU-231

12.8 kg 28.2 lb

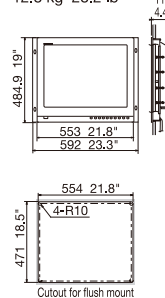

Display Unit MU-270W

13 kg 28.7 lb

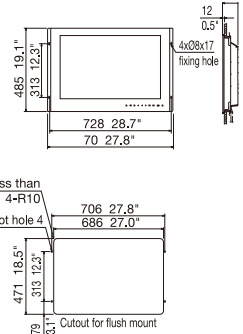

Antenna Unit for FAR-2318/2328/2328W/2328-NXT

Radiator XN12CF 46.2 kg 101.9 lb
XN20CF 48.1 kg 106.1 lb
XN24CF 49.3 kg 108.7 lb

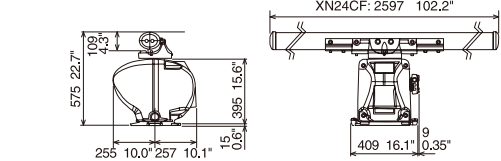

Antenna Unit for FAR-2338S/2338SW/2338S-NXT

Radiator SN36CF 144 kg 317.5 lb

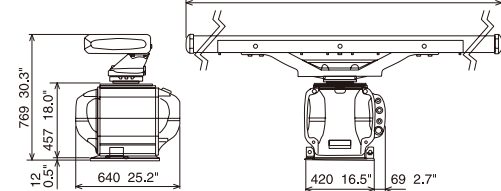

Beware of similar products

All brand and product names are registered trademarks, trademarks or service marks of their respective holders.

SPECIFICATIONS SUBJECT TO CHANGE WITHOUT NOTICE

FURUNO ELECTRIC CO., LTD.
Japan | www.furuno.com
FURUNO U.S.A., INC.
U.S.A. | www.furunousa.com
FURUNO PANAMA S.A.
Republic of Panama | www.furuno.com.pa
FURUNO (UK) LIMITED
U.K. | www.furuno.co.uk
FURUNO NORGE A/S
Norway | www.furuno.no

FURUNO DANMARK A/S
Denmark | www.furuno.dk
FURUNO SVERIGE AB
Sweden | www.furuno.se
FURUNO FINLAND OY
Finland | www.furuno.fi
FURUNO POLSKA Sp. z o.o.
Poland | www.furuno.pl
FURUNO DEUTSCHLAND GmbH
Germany | www.furuno.de

FURUNO FRANCE S.A.S.
France | www.furuno.fr
FURUNO ESPAÑA S.A.
Spain | www.furuno.es
FURUNO ITALIA S.R.L.
Italy | www.furuno.it
FURUNO HELLAS S.A.
Greece | www.furuno.gr
FURUNO (CYPRUS) LTD
Cyprus | www.furuno.com.cy

FURUNO EURUS LLC
Russian Federation | www.furuno.ru
FURUNO SHANGHAI CO., LTD.
China | www.furuno.com/cn
FURUNO CHINA CO., LTD.
Hong Kong | www.furuno.com/cn
FURUNO KOREA CO., LTD
Korea
FURUNO SINGAPORE
Singapore | www.furuno.sg

PT FURUNO ELECTRIC INDONESIA
Indonesia | www.furuno.id
FURUNO ELECTRIC (MALAYSIA) SND. BHD.
Malaysia | www.furuno.my