

NAVpilot

Model NAVpilot-700/711C

AUTOPILOT



NEW!
Color
LCD



Kick back, relax and let NAVpilot steer you to your destination!

FURUNO NAVpilot is a revolutionary autopilot with a sunlight viewable display designed for a variety of vessels.

It utilizes a self-learning and adaptive software algorithm, and plays the ultimate role in course keeping capability, dynamically adjusting essential parameters for navigation i.e., vessel speed, trim, draught, tide and wind effects, dead band, weather, etc. These parameters are stored in the system memory and continuously optimized.



Double-Din size 4.6" Mono LCD



Single-Din size 4.1" Color LCD



3.6" Mono LCD Handheld Display (Option)



- ▶ **Furuno Fantum Feedback** - allows for no physical rudder feedback unit for a streamlined installation and precise course control
- ▶ **Optional revolutionary SAFE HELM and POWER ASSIST** brings unrivaled steering control and comfort at the helm*
- ▶ **Selectable "Economy" and "Precision" Navigation Modes** combine adaptive technology providing fuel and power savings of up to 2.5% or more.**

- ▶ **Volvo Penta IPS compatibility**
- ▶ **"Precision" XTE accuracy:** within 0.003 nm
- ▶ **Perfect for inboard or outboard power boats and sail boats**
- ▶ **Simple one-touch mode selection** enables flexible steering and course control
- ▶ **Autopilot control available from NavNet TZtouch**

* Required Options - HRP11 or HRP17 Pump and FPS8 Power Steering Module
 ** Based on Furuno testing and "Scenarios for a Clean Energy Future 2000" - U.S. Department of Energy (www.ornl.gov/sci/eere/cef)



NAVpilot's remarkable self-learning, adaptive software is developed by collaborative works between FURUNO and FLSI.



Fantu

From the first dock-side setup through the last voyage you made, NAVpilot continues to learn your vessel's steering characteristics. This allows dynamic adjustments to the boat's steering for vessel speed, trim, draft, tide and wind effects, weather, etc. These characteristics are stored in the processor's memory where they are continuously optimized to make the NAVpilot more versatile.

Auto mode



NAVpilot consistently maintains the desired heading, but the vessel may drift off course due to the effects of tide and wind.

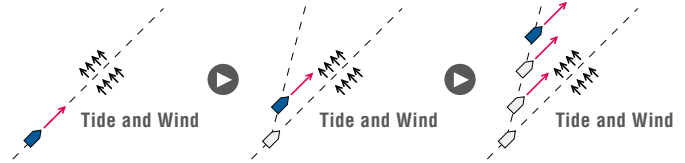

Advanced mode



NAVpilot consistently maintains the desired heading while compensating for the effects of tide and wind.



NAV mode / Route tracking



NAVpilot steers the vessel towards the current waypoint while compensating for the effects of tide and wind.

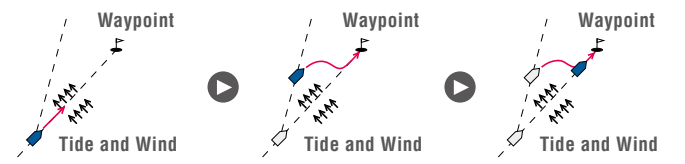

When connected to a GPS Navigator, NAVpilot steers the vessel to follow a series of waypoints in succession. Upon arriving at each waypoint or destination, audible and visual alerts are activated.



Wind mode*



NAVpilot consistently maintains the desired heading toward true or apparent wind direction while compensating for the effects of tide and wind.

* This mode is available for sailing craft only. Wind data input is required.

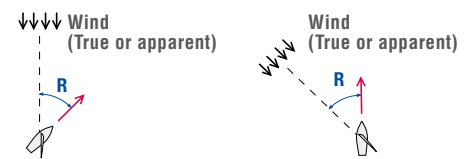

FishHunter

The NAVpilot will activate the FishHunter to perform square, zigzag, circle, orbit, spiral or figure eight maneuvers around the specified target at a user selected distance. This feature can also be used for Man Overboard (MOB).



Square

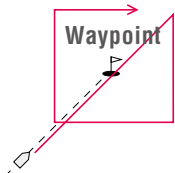

Zigzag

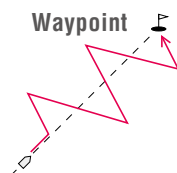

Orbit

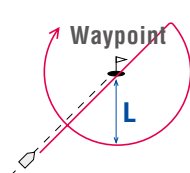
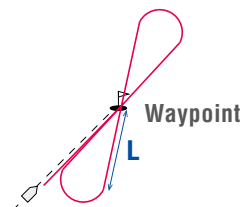
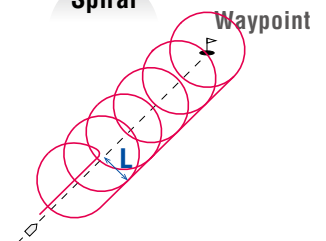

Figure 8



Spiral



Fantum Feedback

Self-learning and adaptive software

Power Assist

Safe Helm

IPS Compatibility



Bright & Clear Display

New Display modes for NAVpilot-711C

for DAY time vision - white

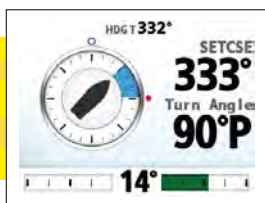

Turn mode

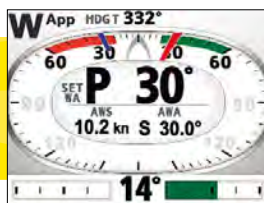

Wind

for NIGHT time vision - black



Auto mode



Highway

Various display modes are available, allowing you to customize the data to suit your own preferences with either digital or analog graphics.

The new NAVpilot-711C features a color day/night graphic display, giving you much better sunlight viewability during the day, while not affecting your night vision when the sun goes down.

Display modes for NAVpilot-700

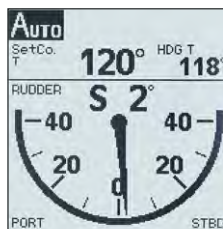

Rudder Angle

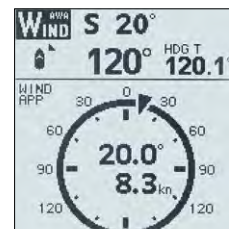

Wind

SAFE HELM / POWER ASSIST



FURUNO Power-assist Steering

The optional SAFE HELM and POWER ASSIST features* provide a unique interface to the vessel's hydraulic hand steering system, providing unrivaled comfort and control of the vessel's steering directly from any manual helm on the vessel. These two modes greatly reduce steering effort and enhance the safety of your vessel's autopilot. * Required Options - HRP11 or HRP17 Pump and FPS8 Power Steering Module

SAFE HELM

The SAFE HELM temporarily switches the NAVpilot to manual steering for a specified time interval, taking it out of an automatic steering mode (AUTO, NAV, etc.) After the time interval has elapsed, SAFE HELM is deactivated and the previous automatic steering mode is restored.

POWER ASSIST

The POWER ASSIST is a unique helm-activated assisted steering feature that can augment and possibly replace separate electric and power-robbing, engine-driven power steering systems on many vessels. POWER ASSIST reduces steering system complexity and costs while increasing economy.



Furuno Fantum Feedback



FANTUM FEEDBACK

Furuno's all-new "Fantum Feedback" NAVpilot software clears the path to a simplified installation, while also delivering enhanced steering control. With Fantum Feedback, NAVpilot outboard installations no longer require use of a physical rudder feedback unit.

Fantum Feedback is a menu-selectable feature available in the latest NAVpilot-700 series software. This new software was developed and extensively tested on a wide variety of outboard vessels with hydraulic steering and reversing pump control. Fantum Feedback achieves precise course control, from slow trolling speeds to high-speed cruising, utilizing a newly developed gain process, rather than traditional rudder angle based control.





Furuno's new NAVpilot series is designed to match the NavNet TZtouch, NavNet 3D, FI-50 Instrument series and other navigation equipment. The "Plug and Play" CAN bus interface allows for easy installation and exceptional interface ability. The diagrams below show typical installations for power and sail boats.



POWER BOAT

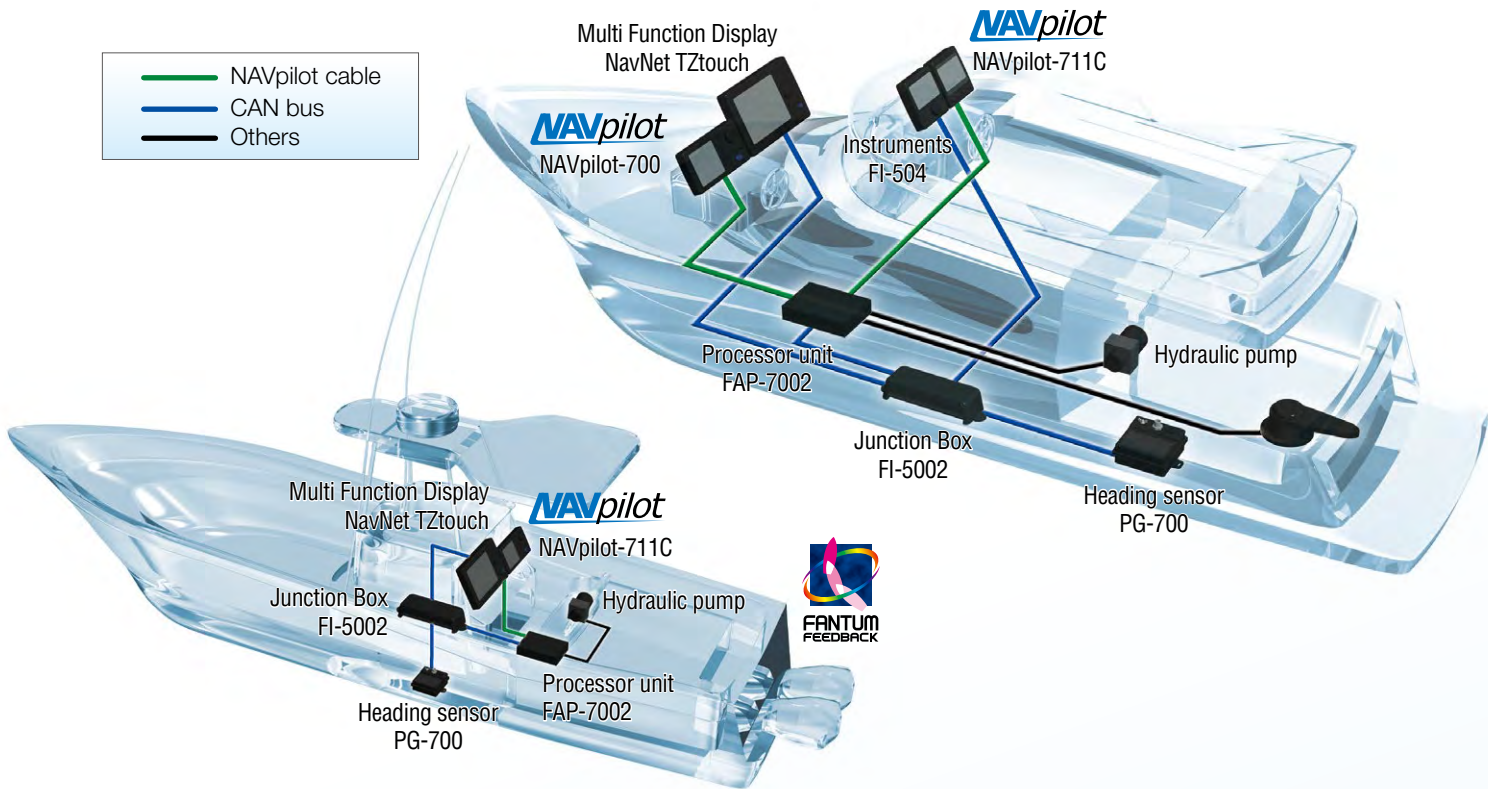

SAIL BOAT

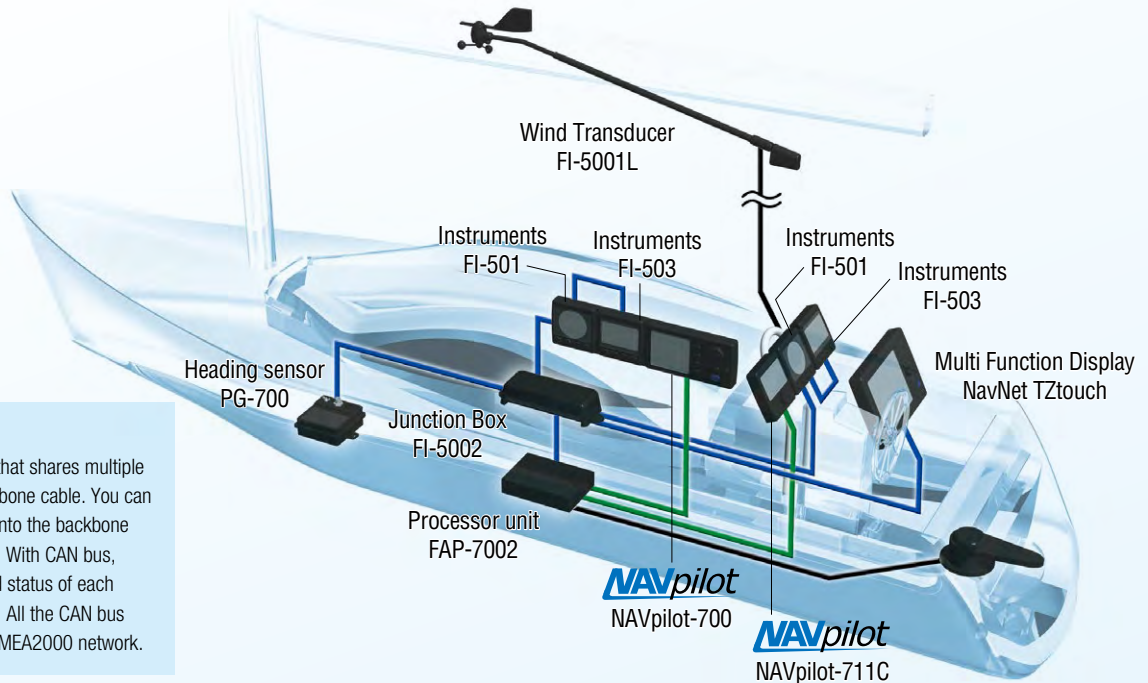

What is CAN bus?

CAN bus is a communication protocol that shares multiple data and signals through a single backbone cable. You can simply connect any CAN bus devices onto the backbone cable to expand your network onboard. With CAN bus, IDs are assigned to all the devices, and status of each sensor in the network can be detected. All the CAN bus devices can be incorporated into the NMEA2000 network.

SPECIFICATIONS

	NAVipilot-700	NAVipilot-711C
CONTROL UNIT		
Display	4.6" Monochrome LCD	4.1" Color LCD
Effective Display Area	85.2 (W) x 85.2 (H) mm	82.6 (W) x 61.9 (H) mm
Pixel Number	160 x 160 dots	320 x 240 dots
Backlight		8 steps
Contrast	16 steps	-
PROCESSOR UNIT		
Rudder Angle Adjustment	STBY, Auto, Dodge, Turn, Remote, Advanced auto*, Navigation*, Wind*, Fish Hunter™* * external data required	
Sea Condition Adjustment	AUTO/MANUAL-CALM/MODERATE/ROUGH	
Rudder Angle Settings	10 - 45 deg	
Alarm	Heading deviation, Cross-track error*, Ship's speed*, Depth*, Water temperature*, Wind*, Watch, Log trip*, * external data required	
INTERFACE		
Ports	CAN bus (NMEA2000) : 1, NMEA0183: 2	
Input	(NMEA0183) AAM, APB, BOD, BWC, BWR, DBT, DPT, GGA, GLL, GNS, HDG, HDM, HDT, MTW, MWV, ROT, RMB, RMC, THS, TLL, VHW, VTG, VWR, VWT, XTE, ZDA (CAN bus) 059392/904, 060928, 061184, 126208/720/992/996, 127250/251/258/488/489, 128259/267, 129025/026/029/033/283/284/285, 130306/310/311/312/313/314/577/818/821/827/880	
Output	(NMEA0183) DBT, DPT, GGA, GLL, GNS, HDG, HDM, HDT, MTW, MWV, RMB, RMC, ROT, RSA, VHW, VTG, VWR, VWT, ZDA (CAN bus) 059392/904, 060928, 061184, 126208/464/720/992/996, 127237, 245/250/251/258, 128259/267, 129025/026/029/033/283/284/285, 130306/310/311/312/822/823	
ENVIRONMENT		
Temperature	-15°C to +55°C	
Waterproofing	Processor unit	IP20
	Other unit	IP56
POWER SUPPLY		
	12-24 VDC: 4.0 - 2.0 A (excluding pump)	
EQUIPMENT LIST		
Standard	Control Unit (FAP-7001 or 7011C), Processor Unit FAP-7002, Installation Materials and Spare Parts	
Options	Control Units, Flush Mount Kits, Bracket-mount Kits, Cradle, Rudder Reference Units FAP6112-200, Remote Controllers, Cables, Connectors, Junction Box, Pump Unit, FPS8 Power Steering Module, Volvo Interface Kit FAP-6300	

NAVipilot-700 Control Unit (Bracket-mount) FAP-7001

0.9 kg 1.9 lb

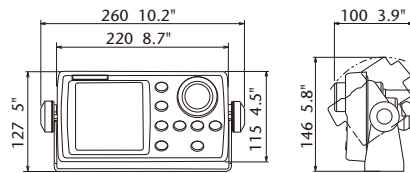

NAVipilot-711C Control Unit (Surface-mount only)

0.33 kg 0.7 lb

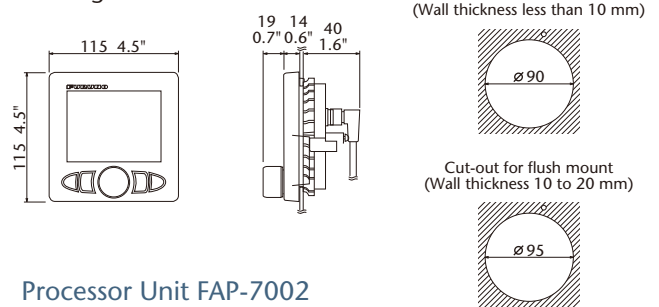

NAVipilot-700 Control Unit (Surface-mount)

0.62 kg 1.4 lb

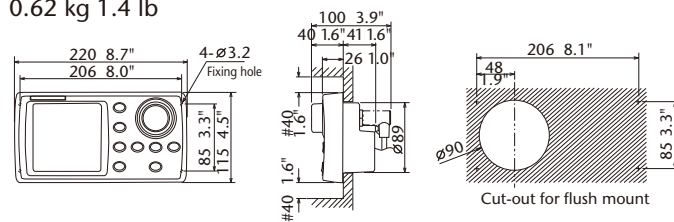

Processor Unit FAP-7002

1.9 kg 4.2 lb

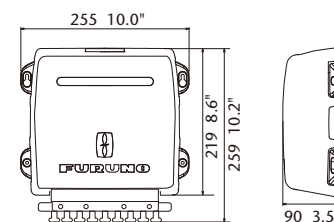

NAVipilot-700 Control Unit (Flush-mount)

0.64 kg 1.4 lb

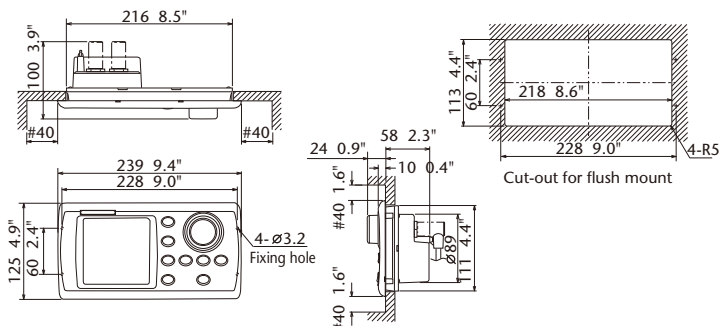

<http://www.furuno.com/special/en/navipilot/>
Visit our website to watch guided videos, see screenshots and learn more about features of NAVipilot-700 series.

All brand and product names are registered trademarks, trademarks or service marks of their respective holders.

SPECIFICATIONS SUBJECT TO CHANGE WITHOUT NOTICE

FURUNO ELECTRIC CO., LTD.
Nishinomiya, Hyogo, Japan
www.furuno.com

FURUNO U.S.A., INC.
Camas, Washington, U.S.A.
www.furunousa.com

FURUNO (UK) LIMITED
Havant, Hampshire, U.K.
www.furuno.co.uk

FURUNO FRANCE S.A.S.
Bordeaux-Mérignac, France
www.furuno.fr

FURUNO ITALIA S.R.L.
Gatteo Mare, Italy

FURUNO ESPAÑA S.A.
Madrid, Spain
www.furuno.es

FURUNO DANMARK A/S
Hvidovre, Denmark
www.furuno.dk

FURUNO NORGE A/S
Ålesund, Norway
www.furuno.no

FURUNO SVERIGE AB
Västra Frölunda, Sweden
www.furuno.se

FURUNO FINLAND OY
Espoo, Finland
www.furuno.fi

FURUNO POLSKA Sp. z o.o.
Gdynia, Poland
www.furuno.pl

FURUNO EURUS LLC
St. Petersburg, Russian Federation
www.furuno.com.ru

RICO (PTE) LTD
Singapore
www.rico.com.sg

FURUNO DEUTSCHLAND GmbH
Rellingen, Germany
www.furuno.de

FURUNO HELLAS S.A.
Piraeus, Greece
www.furuno.gr

FURUNO (CYPRUS) LTD
Limassol, Cyprus
www.furuno.com.cy

FURUNO SHANGHAI CO., LTD.
Shanghai, China
www.furuno.com/cn