

MULTI BEAM SONAR

Model ***F3 Series***

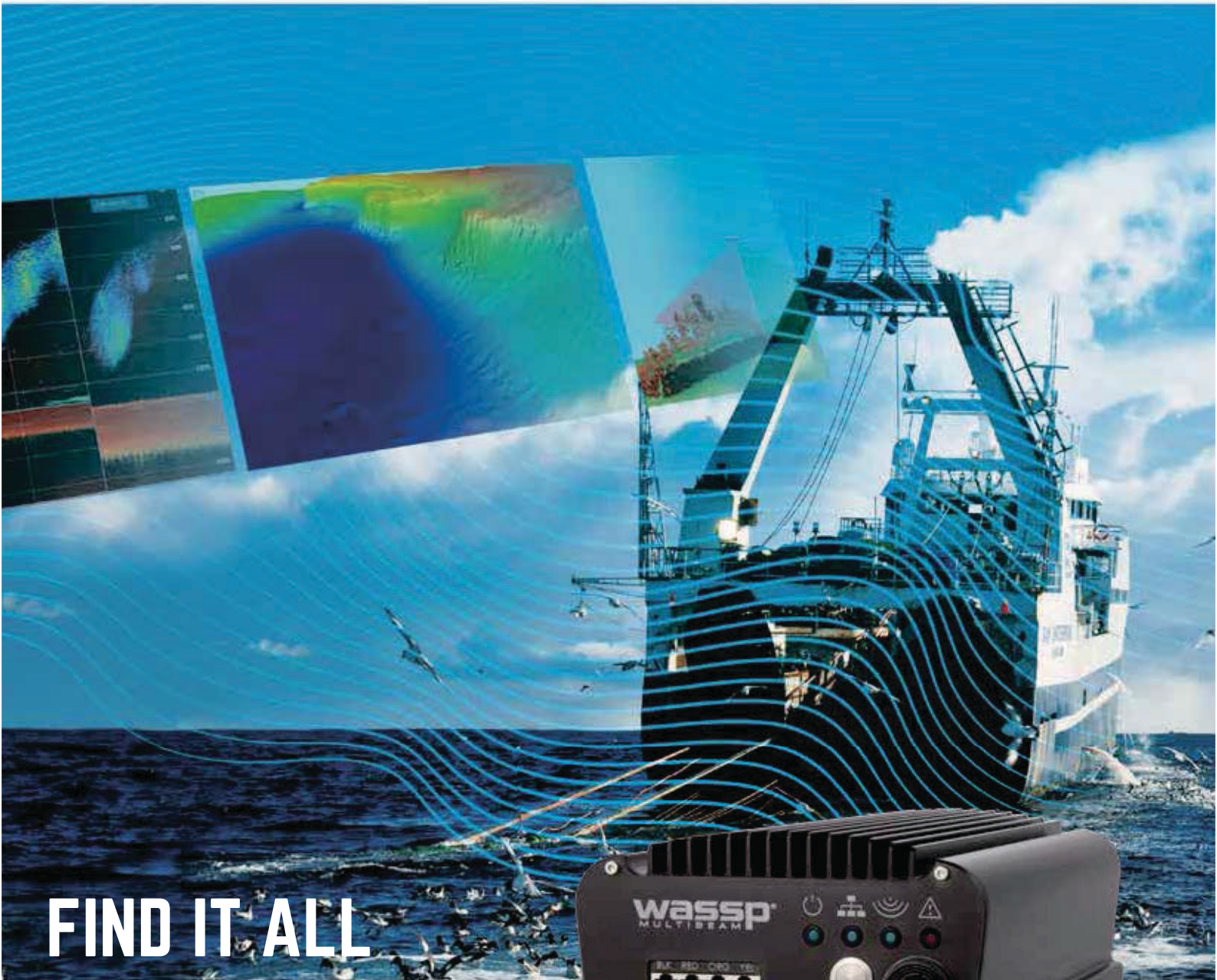

FIND IT ALL



This next generation WASSP multi beam sonar – accurate, versatile, user-friendly and most

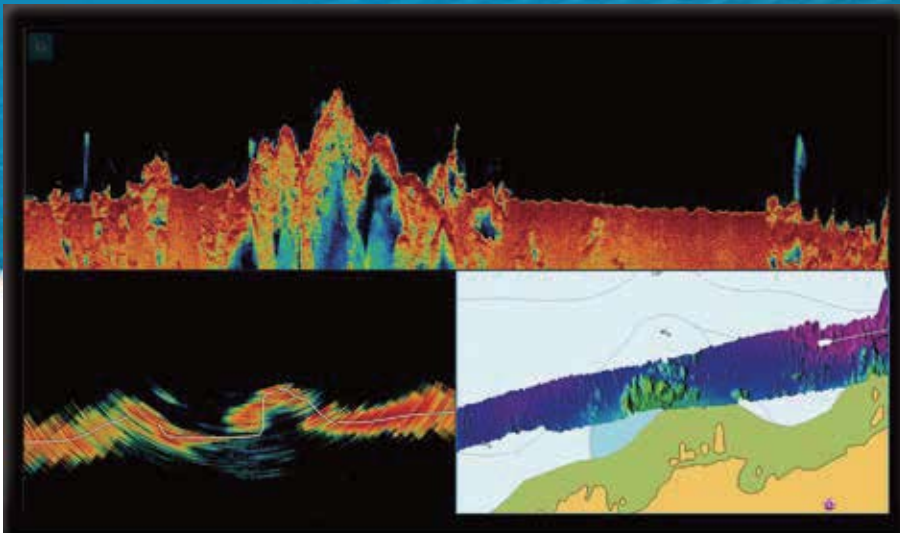

User adjustable Multi Functional Display

Generate your own personal Multibeam Chart

The F3 series is set to revolutionise inshore fisheries with its Wideband CHIRP technology. Scanning a 120 degrees swath port to starboard and using 224 beams, the F3 series delivers each and every time. By using advanced signal processing, you get a complete picture of seafloor bathymetry with ease.

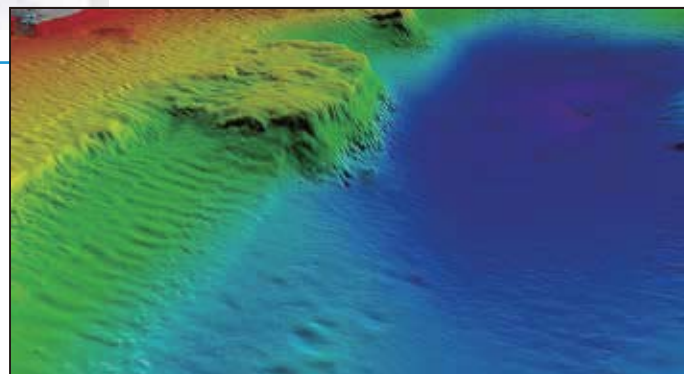

WASSP 3D

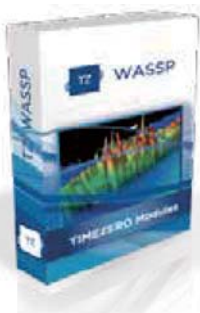

- ▶ Capability to save chart into the CDX software
- ▶ TIMEZERO compatible with optional licence

New easy-to-use interface

The F3 series introduce a new simplified software “WASSP CDX” for control, visualisation and data management while still providing a comprehensive set of functions to meet the most demanding fishing requirements.

- ▶ Cost-effective solution for multiple applications
- ▶ Choose your own functions with new licensing options



... delivers on every front ... importantly, scalable to your exact needs.

All-in-one DRX transceiver, incredibly versatile and ready for the next technology advances



This innovative all-in-one “BlackBox” is not just a robust hardware platform but also introduces cutting-edge technical innovations and incredible versatility for finding your catch. This opens countless new possibilities for your operations.

► Easy to install/commission

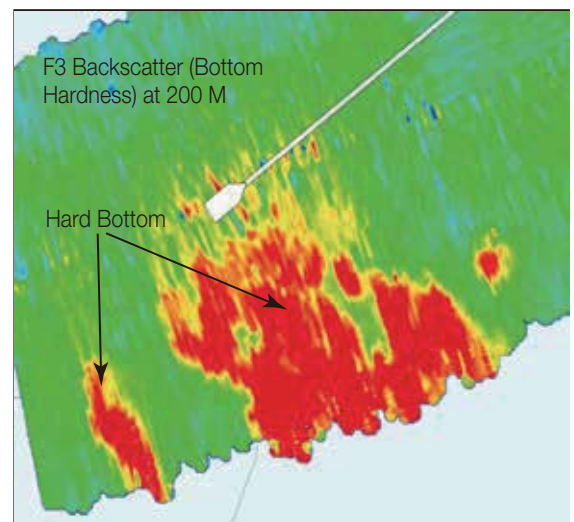
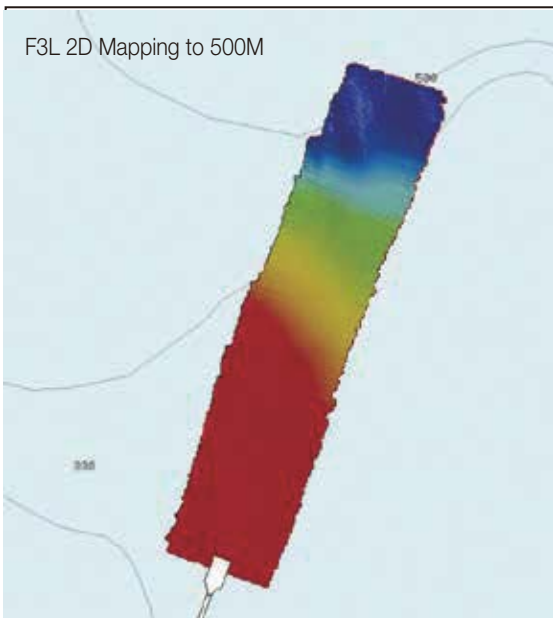
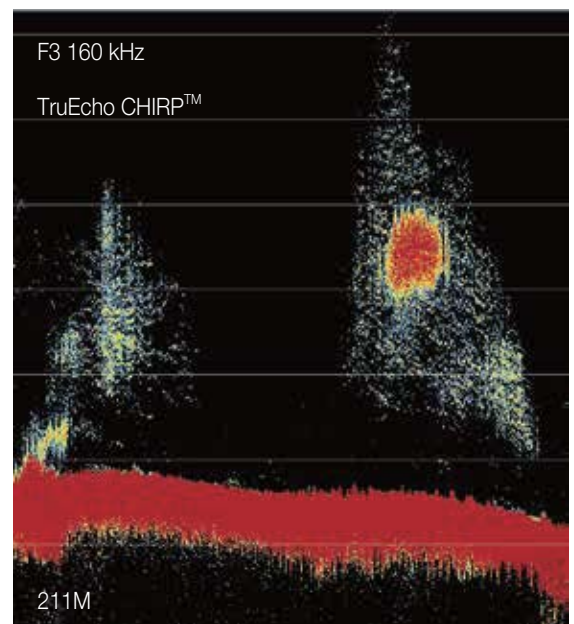
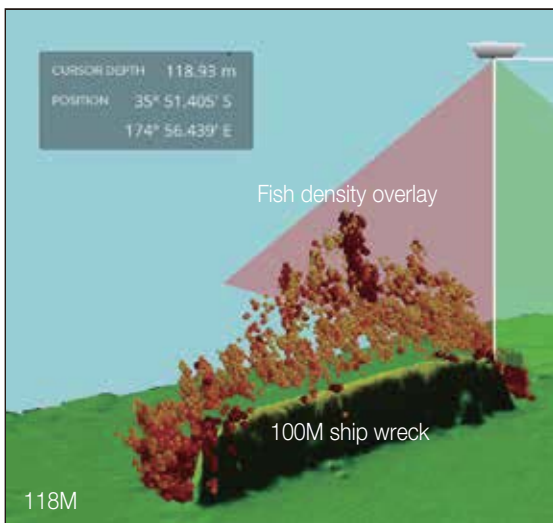

INSHORE FISHING

The scalable system has a wide range of features and capabilities; all manner of inshore fishing types can be optimised, ensuring efficiency and increased productivity in all fishing methods employed.

The system can be tailored for all types of inshore fisheries.

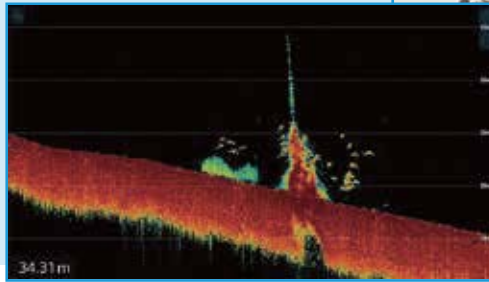

POTTING

The 3D presentation of the seabed, coupled with the optional backscatter function, to aid in the assessment of seafloor hardness, ensures the best location of pots in a range of environments.



TRAWLER

With accurate water column and seabed information at hand, skippers are better informed, and can make decisions ensuring they maximise their catch while minimising time at sea.

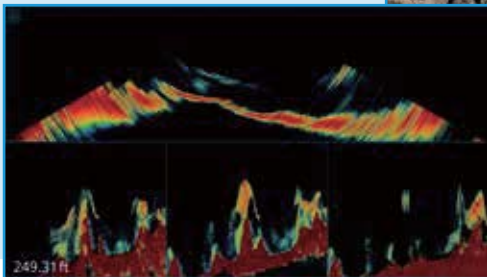

WASSP transducer

- ▶ The WASSP sonar transducer is available in 2 frequencies
 - 136-184 kHz Wideband (160 kHz center)
 - 68-92 kHz Wideband (80 kHz center)



MULTIBEAM SONAR *F3 Series*

DISCOVER A NEW UNDERWATER WORLD

Outstanding performance, versatility and value. That's what you expect and exactly what you get with the new WASSP F3 series.

This next generation multi beam sonar has been redesigned from the ground up around a new fully digital DRX transceiver. It delivers on every front - accurate, versatile, user-friendly and most importantly, scalable to your exact needs.

The only thing that hasn't changed with the F3 series is our commitment to bring you a multi beam sonar at a cost-effective price.



www.mackaymarine.com

Mackay Marine – High Seas

+1 281 479 1515 marinesales@mackaymarine.com

Mackay Communications, Satellite Solutions

+1 919 850 3100 satserv@mackaycomm.com

Mackay Marine Canada

+1 902 469 8480 sales.canada@mackaymarine.com

Mackay Marine Alaska & Pacific Northwest

+1 206 282 8080 ballard@mackaymarine.com

MULTI BEAM SONAR F3/F3i/F3L/F3Li

Models: F3 (WMB-1320F) F3L (WMB-1320FL)
F3i (WMB-1320Fi) F3Li (WMB-1320FLi)

Specifications

1. GENERAL

Transmitting frequency Wide band; F3/F3i: 160 kHz, F3L/F3Li: 80 kHz
Effective beamwidth F3/F3i: 200m, F3L/F3Li: 450 m
Beam width 120° x 4° (Aftships x Fore-aft)
PS: 4.4°
Beam spacing FA: 3.2°
Depth F3: 200 m* (Side Beam Best Performance)
400 m* (Main Beam Directly Under Boat)
F3L: 450 m* (Side Beam Best Performance)
900 m* (Main Beam Directly Under Boat)
*Depth capability subject to a variety of external factors
Max range resolution 2 cm
Power supply unit 9 to 32 VDC
Bottom detections Amplitude & Phase
Tide correction Fully Geo Referenced

2. INTERFACE

NMEA0183/RS422/RS232 GGA, GPK, GLL, HDG, HDM, HDT, HVE, PASHR, PTNL PFEC, RMC, RCD, TSS1, ZDA GbE
Ethernet
NMEA2K
Other Interfaces PPS, KP, Remote Power

3. DISPLAY & FUNCTIONALITY

Bathymetry, Sonar polar view, Sounder (single, triple & quint beam)
(Licensing options)
Backscatter, Open Client Support, Water Column Targets, Uncorrected Data, XYZ export, Sidescan, RTK tides, other export formats*

* available in 2017

4. USER INTERFACE

WASSP CDX
TimeZero pro** Option
** Requires WASSP interface module & excludes 3rd party software.

5. MINIMUM PC SPECS

OS Windows 8.1, 10
CPU 2 Ghz, 4 Cores/4 Threads
Memory 8 GB (Min. 4 GB)
Graphics Direct X11
Screen resolution Full HD 1920 x 1080 (Min. XGA 1024 x 768)
SSD 2 TB (Min. 250 GB)
Network Ethernet - GbE, Wifi-802.11ac
Dual screen support Yes

6. ENVIRONMENTAL CONDITIONS (Transceiver unit)

Ambient temperature 0°C to +50°C (storage:-20°C to +85°C)
Humidity/Damp heat IEC60945, 93 % or less at +40°C
Vibration IEC60945 Ed.4
Waterproofing IP53, Bulkhead mounted (IP67 option available)

Equipment List

Standard

- Transceiver unit DRX
- WASSP CDX (PC application)
- Transducer unit F3 (G3 TRANSDUCER: 160 kHz) with 10 m cable
Transducer unit F3L (G3 TRANSDUCER: 80 kHz) with 20 m cable
- WASSP sensor package* *For F3i (WMB-1320Fi)/F3Li (WMB-1320FLi).

Option

- F3 (G3 TRANSDUCER: 160 kHz) with 20 m cable
- Gland (aluminum/plastic/steel)
- Satellite Compass plus cable with WASSP sensor box*
- WASSP sensor box

*For F3 (WMB-1320F)/F3L (WMB-1320FL).

TRANSCIVER UNIT

DRX (F3 DRX) 8.3 kg 18.3 lb

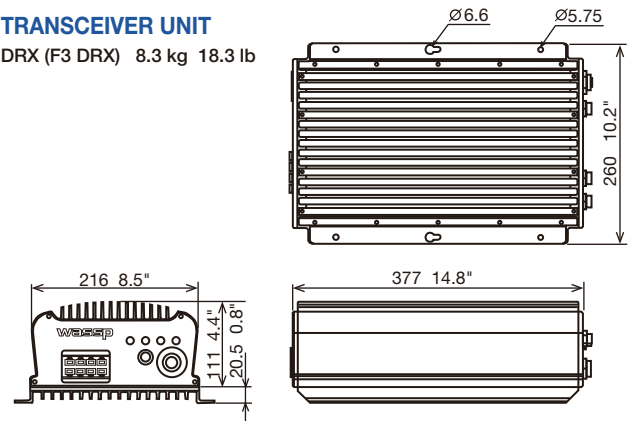

TRANSDUCER

WMB-160 (G3 TRANSDUCER: 160 kHz) 15 kg 33.1 lb (cable dependent)

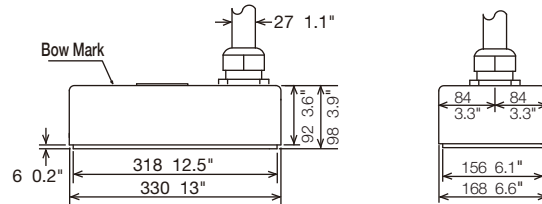

WMB-80 (G3 TRANSDUCER: 80 kHz) 39 kg 86 lb (cable dependent)

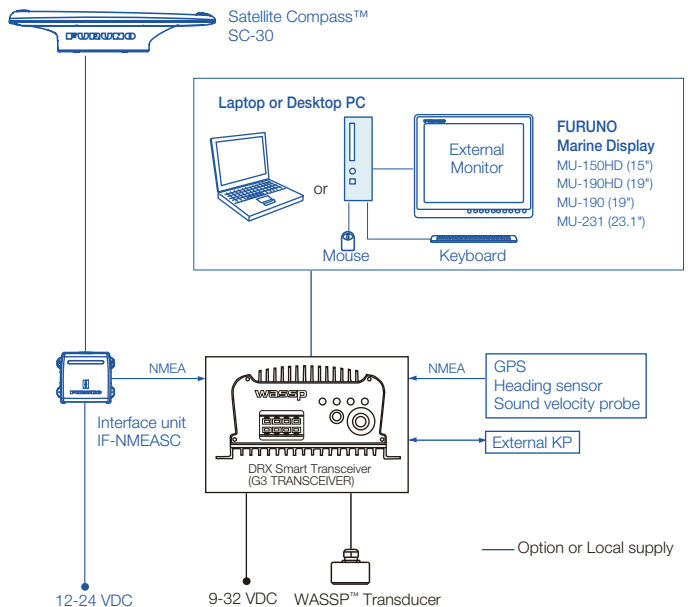
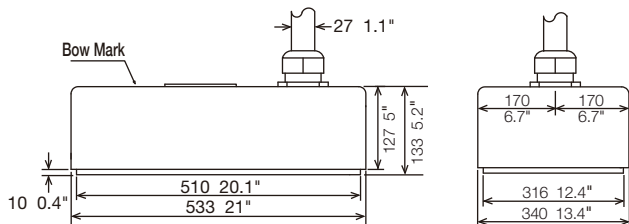

Beware of similar products

All brand and product names are registered trademarks, trademarks or service marks of their respective holders.

SPECIFICATIONS SUBJECT TO CHANGE WITHOUT NOTICE

FURUNO ELECTRIC CO., LTD.
Japan | www.furuno.com

FURUNO U.S.A., INC.
U.S.A. | www.furunousa.com

FURUNO PANAMA S.A.
Republic of Panama | www.furuno.com.pa

FURUNO (UK) LIMITED
U.K. | www.furuno.co.uk

FURUNO NORGE A/S
Norway | www.furuno.no

FURUNO DANMARK A/S
Denmark | www.furuno.dk

FURUNO SVERIGE AB
Sweden | www.furuno.se

FURUNO FINLAND OY
Finland | www.furuno.fi

FURUNO POLSKA Sp. z o.o.
Poland | www.furuno.pl

FURUNO DEUTSCHLAND GmbH
Germany | www.furuno.de

FURUNO FRANCE S.A.S.
France | www.furuno.fr

FURUNO ESPAÑA S.A.
Spain | www.furuno.es

FURUNO ITALIA S.R.L.
Italy | www.furuno.it

FURUNO HELLAS S.A.
Greece | www.furuno.gr

FURUNO (CYPRUS) LTD
Cyprus | www.furuno.com.cy

FURUNO EURUS LLC
Russian Federation | www.furuno.ru

FURUNO SHANGHAI CO., LTD.
China | www.furuno.com/cn

FURUNO CHINA CO., LTD.
Hong Kong | www.furuno.com/cn

FURUNO SINGAPORE
Singapore | www.furuno.sg

PT FURUNO ELECTRIC INDONESIA
Indonesia | www.furuno.id

1-A-17083SS
Catalogue No. CA00001048