



# VHF RADIOTELEPHONE

## JHS-770S/780D



*— a first class VHF with an advanced modular design that allows for maximum installation flexibility*

- Direct call by AIS™**
- Easy operation with JOG dial**
- Intercom & loudhailer function**
- 3.8" high brightness LCD screen**
- 120 seconds recording**

# VHF series – performance features

## Unique features

- Available as semi-duplex or full-duplex, this class A VHF radiotelephone incorporates advanced modular design that allows for maximum installation flexibility.



## Direct call by AIS™

When connecting your AIS to the new VHF, new possibilities become available. This innovative feature, unique to JRC, allows you with one push of the button, to quickly navigate through a list of targets in your surrounding area. Bearing, range and MMSI information of target vessels are sorted from the shortest range upwards. You can now easily select the vessel you wish to get in contact with, and send a DSC message immediately.

## Intercom and loudhailer

The VHF radiotelephone has an intercom functionality for easy communication with multiple other VHF controllers onboard! Additionally, to always be in full control and on top of communication with deck or dock hands, a loudhailer function is built in. An optional external speaker with amplifier increases talk power, making your messaging loud and clear, thereby adding to the safety of the vessel.

## Clear display

Improved visibility is realised by the integrated 3.8" high brightness silver LCD screen with excellent sunlight viewability. The main data is displayed in large characters for easy reading.

## Extendable up to 5 controllers

The VHF series configuration allows having up to 5 controllers covering various important sections onboard. Additionally, there is a range of possibilities for connecting extra handsets and printers.

## 120 seconds digital recording

JRC has included a recording function for the last 120 seconds of open squelch (voice).

In situations where loud engines or other background noises disrupt your reception, this characteristic feature enables you to immediately repeat any unclear messages.



# VHF series

## – developed for maximum ease of use

### Wing controller

For wing and/or outside applications, JRC has developed an optional, simplified channel selector. This compact weatherproof unit allows basic operation, such as channel and power selection, and has a channel 16 preset.



### Easy configuration

The JHS-770S/780D is developed upon maximum flexibility, having a separate transceiver and controller allowing flexible installation in confined spaces. Either panel, desktop or overhead mounting is possible with this size reduced VHF radiotelephone.

### Easy operation

The combination of push buttons and JOG dial operation, together with JRC's innovative software including easy menu structures ensures logical, accurate and convenient operation.



Simplified squelch and volume operation

Direct call by AIS™

Easy JOG dial operation

### StarNetwork™

JRC has been providing sales and support of products since 1915! Today, JRC offers comprehensive support through its organisation, in partnership with a world-wide StarNetwork™ of over 270 fully qualified agents, giving support 24 hours a day, 7 days a week, and 365 days a year!





# VHF series - system flexibility

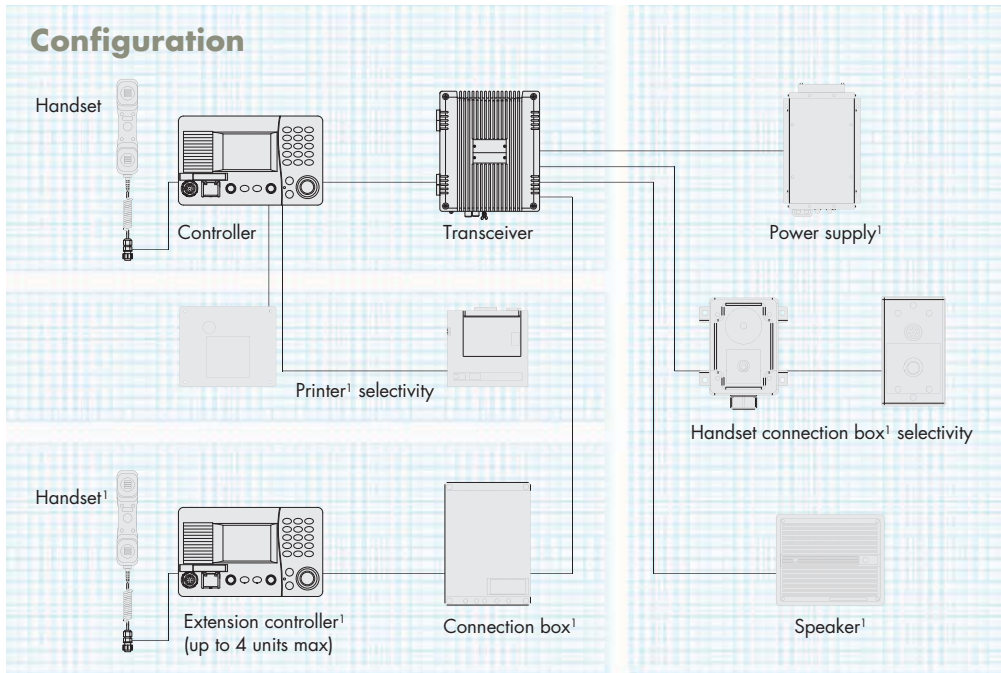

<sup>1</sup>optional products

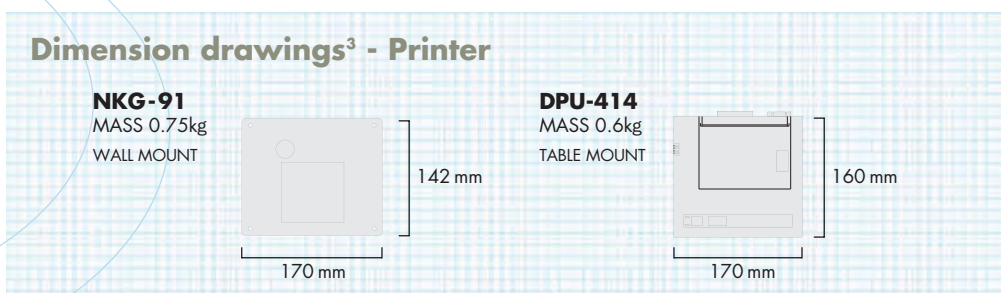
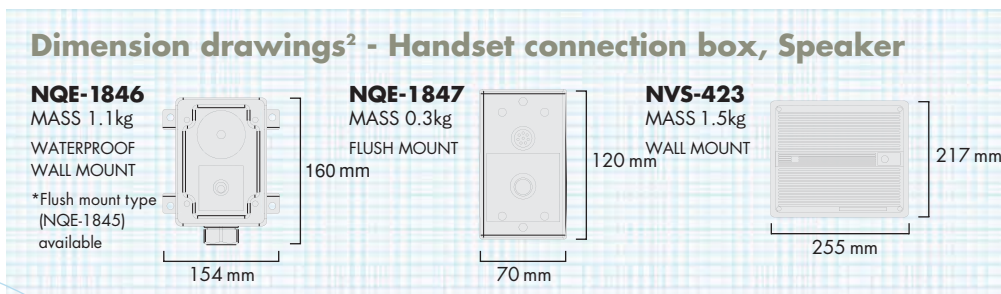
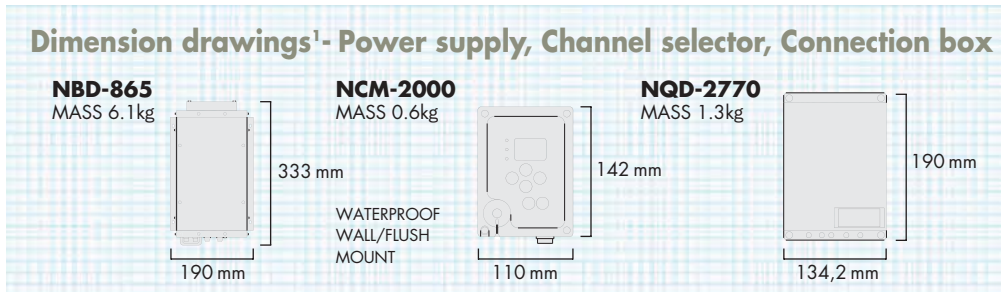

<sup>1 2 3</sup>optional products

# VHF series - dimensions and weights

## Dimension drawings - Controller

**NCM-1770** MASS 1.3kg

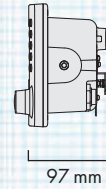
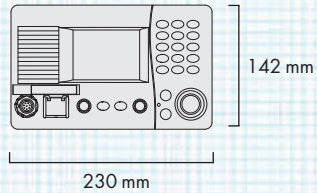

## Dimension drawings - Transceiver, Antenna

**NTE-770S** MASS 6.3kg  
**NTE-780D** MASS 6.9kg

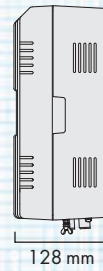
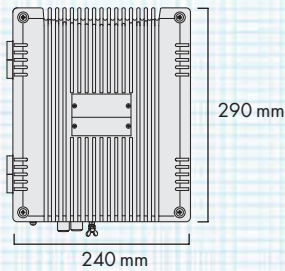

**7ABJD0004**  
MASS 0.3kg

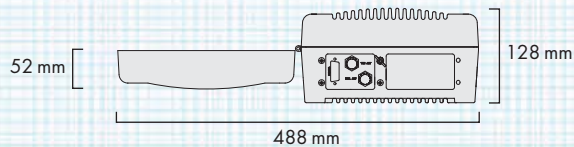
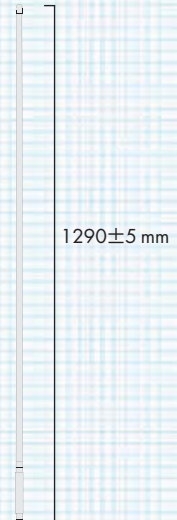

## Dimension drawings - Handset

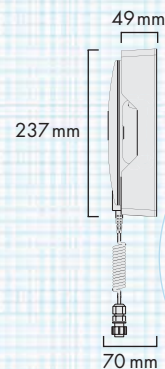
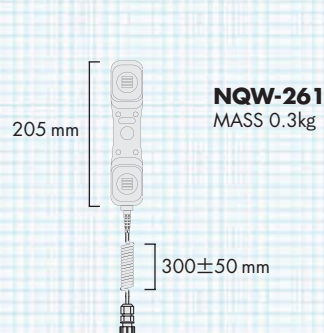



# VHF series

## – specifications

Model	JHS-770S	JHS-780D
GMDSS compliance	✓	
<b>General</b>		
Communication mode	simplex/semi-duplex	simplex/duplex
Frequency range	155.00 - 163.50MHz	
TX	155.00 - 163.50MHz (simplex/semi-duplex), 156.00 - 157.45MHz (duplex)	
RX	155.00 - 163.50MHz (simplex/semi-duplex), 160.60 - 162.05MHz (duplex)	
Output power	25W/1W	
Modulation type	radiotelephone G3E/F3E, DSC/ATIS G2B/F2B	
Channel spacing	25kHz	
Frequency accuracy	within $\pm 10 \times 10^{-6}$	
Antenna impedance	50 $\Omega$ unbalanced	
DSC CH70 receiver	built in	
DSC CH70 frequency	156.525MHz	
DSC received message LOG	20 distress messages 20(TX)+20(RX) non-distress messages	
<b>Channel capacity</b>		
ITU/USA/Canada	57 channels max	
Inland Waterway	57 channels max	
Private	200 channels max (channel steps: 25kHz, 12.5kHz, 10kHz)	
Weather	10 channels max	
Memory	10 channels max	
<b>Inputs</b>		
IEC-61162-1	GPS	
IEC-61162-2	AIS	
<b>Outputs</b>		
IEC-61162-1	VDR/S-VDR	
Audio	600 $\Omega$ 0dBm balanced (to VDR/S-VDR), unbalanced (to ext. loudspeaker) for external printer NKG-91 and DPU-414	
RS232C		
<b>Environmental conditions</b>		
Power voltage	DC 24V +30% -10%	
Current consumption	DC 24V input, 8.3A max	
Ambient condition	temperature: -15°C +55°C (range for full performance 0°C +40°C)	
<b>Optional items</b>		
Power supply unit	NBD-865 (for AC operation)	
Remote VHF controller	NCM-1770(with handset, cradle and cable)	
VHF channel selector	NCM-2000	
Controller connection box	NQD-2770	
Flush mounting kit	MPBC42957(for NCM-1770)	
Controller bracket	MPBX44354	
Handset	NQW-261 (with cradle)	
Handset connection box	NQE-1847	
Handset connection box (waterproof)	NQE-1845(flush mount) / NQE-1846(wall mount)	
Printer (table mount)	DPU-414	
Printer (flush mount)	NKG-91	
External speaker (wall mount)	NVS-423	
External speaker (flush mount)	NVS-423A	
Extension board	CQD-7701 (required for multiple controllers)	

• Specifications may be subject to change without notice.

**For further information, contact:**



marinesales@mackaymarine.com  
+1 281 479 1515  
service@mackaymarine.com  
+1 281 478 6245



Since 1915

**Japan Radio Co., Ltd.**

URL <http://www.jrc.co.jp/eng/>

**Main Office:** Fujisawa bldg. 30-16, Ogikubo 4-chome  
Suginami-ku, Tokyo 167-8540, Japan  
Telephone: +81-3-6832-1816  
Facsimile: +81-3-6832-1845

**Overseas Branches :** Seattle, Amsterdam, Athens, Manila  
**Liaison Offices :** Taipei, Jakarta, Singapore, Hanoi,  
Shanghai, Hamburg, New York