

STARLINK | FLAT HIGH PERFORMANCE KIT SPECIFICATIONS

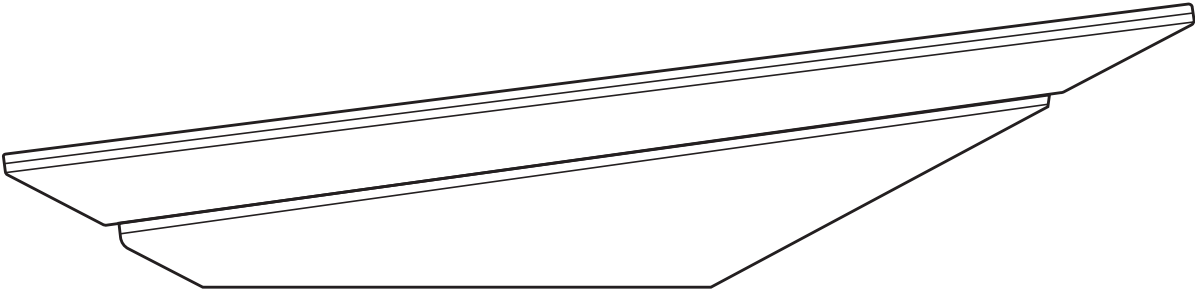

What's In The Box

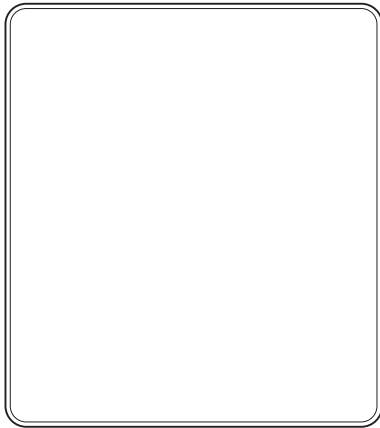

Dish

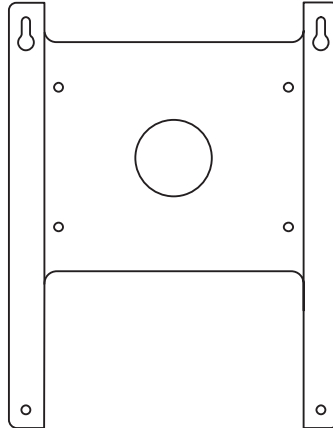

Wedge Mount

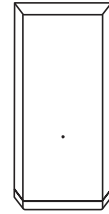

Power Supply

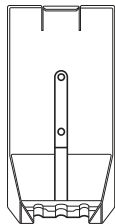

Power Supply Mount

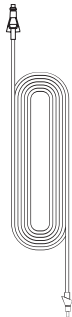

Starlink Cable
25 m
(82 ft)



Ethernet Cable
5 m
(16.5 ft)

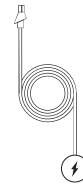

AC Cable (Power Supply)
1.8 m
(6 ft)

Package Weight: 16.25 kg (35.8 lbs)

Package Dimensions: 679 x 613 x 191 mm (26.7 x 24.1 x 7.5 in)

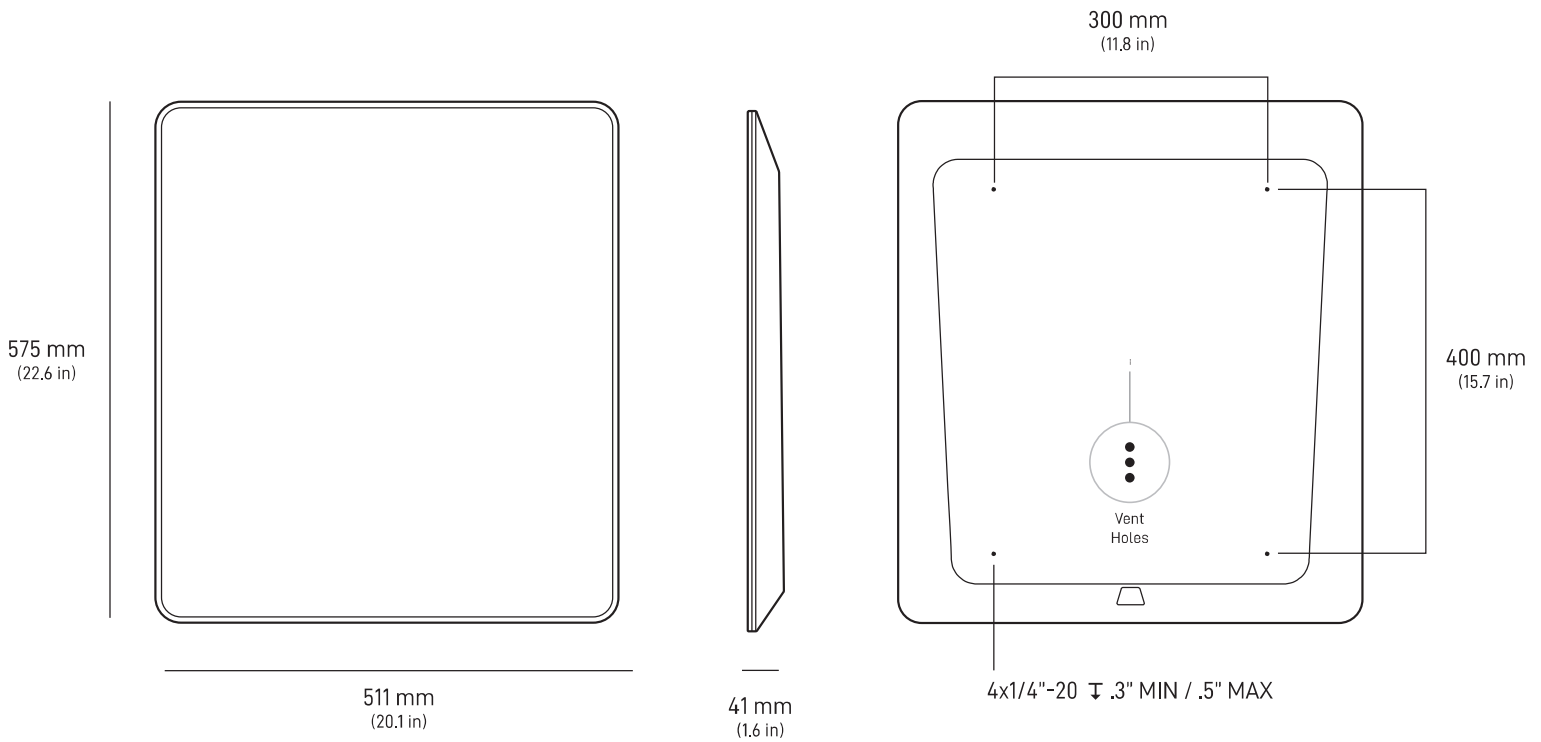

Antenna	Electronic Phased Array
Field of View	140°
Orientation	Fixed
Dish Weight	5.9 kg / 13 lbs without Cable 8.1 kg / 17.9 lbs with 25 m / 82 ft Cable
Environmental Rating	IP56
Operating Temperature	-30°C to 50°C (-22°F to 122°F)
Wind Speed	Survivable: 280 kph+ (174 mph+)
Snow Melt Capability	Up to 75 mm / hour (3 in / hour)
Power Consumption	Average: 110-150 W
User LAN	RJ45 Cable

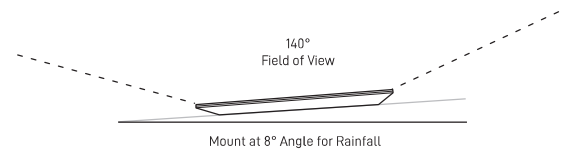

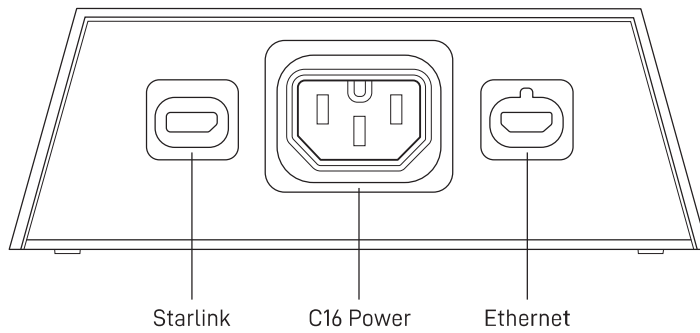
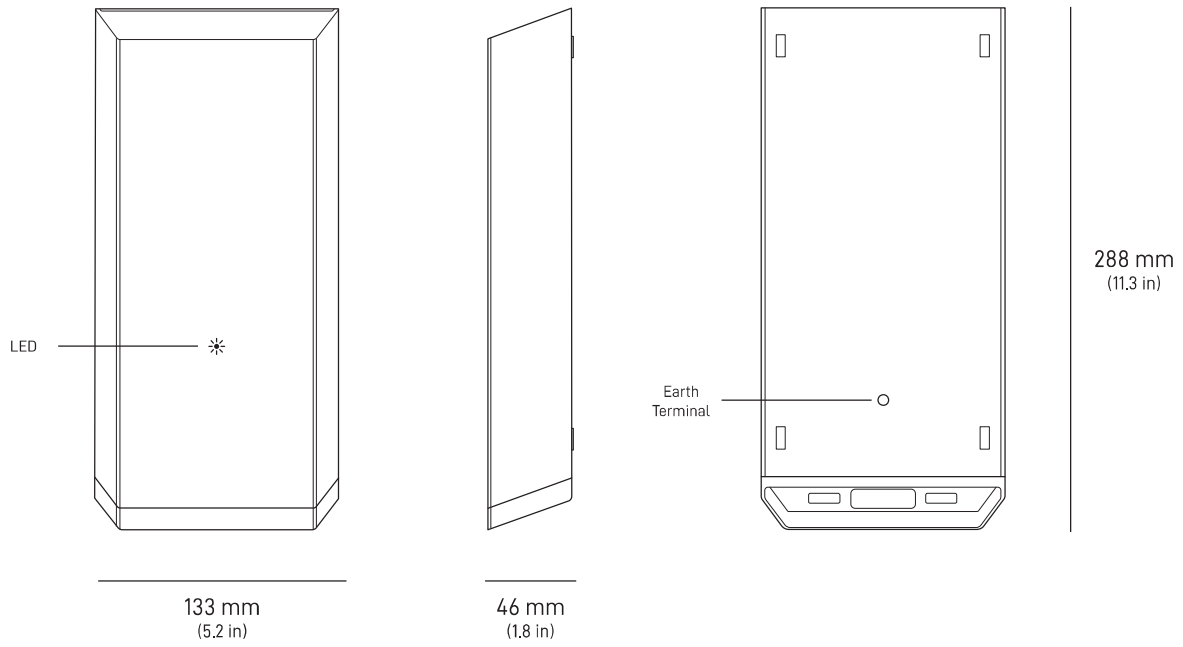

Environmental Rating	IP56
Operating Temperature	-30°C to 50°C (-22 to 122°F)
Weight	1.5kg (3lbs)
Grounding	Dedicated Earth Terminal
Power Specifications	100-240V - 6.3A 50 - 60 Hz
Mounting	Included Mount

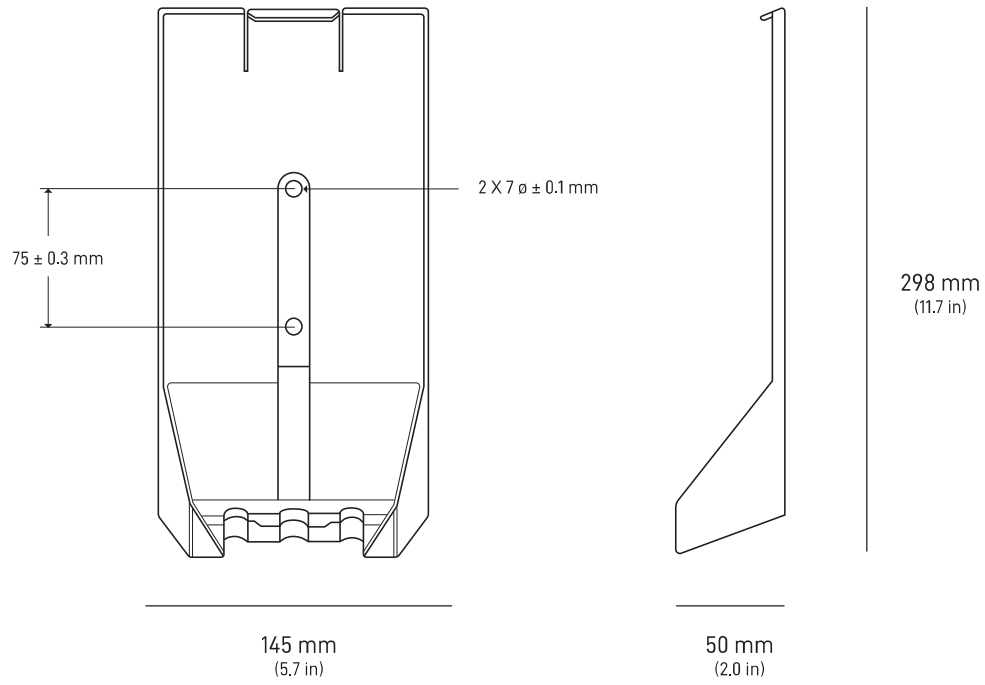

WEDGE MOUNT

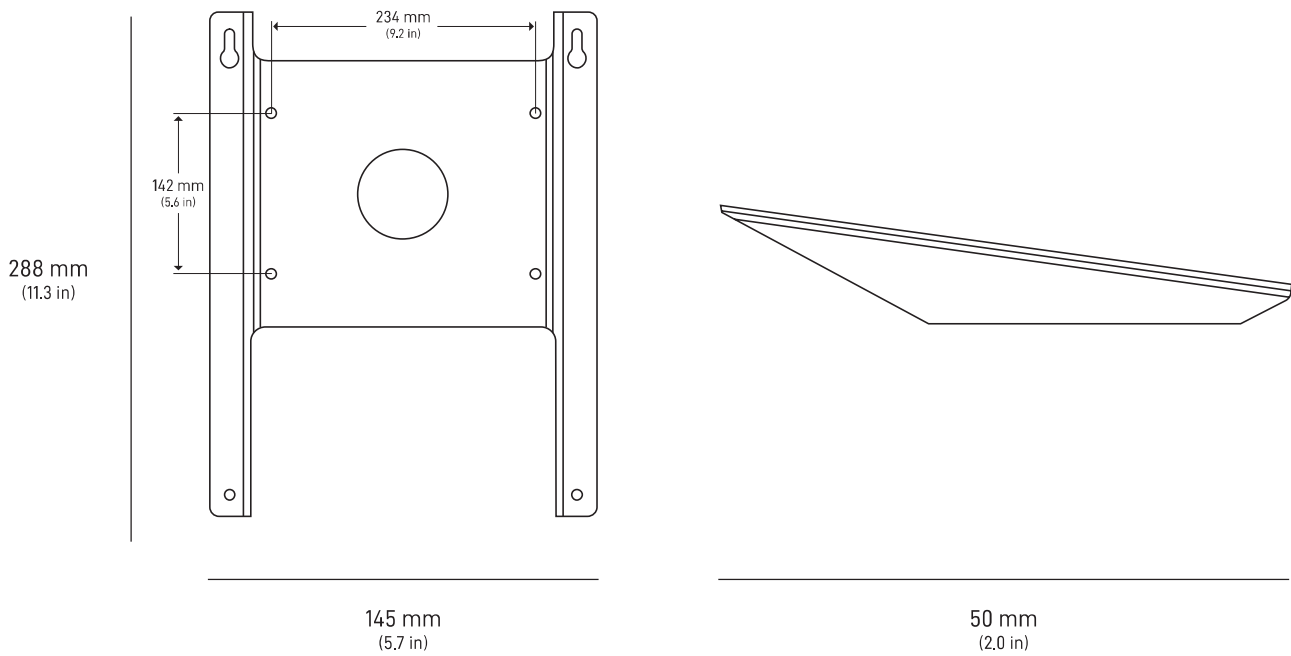

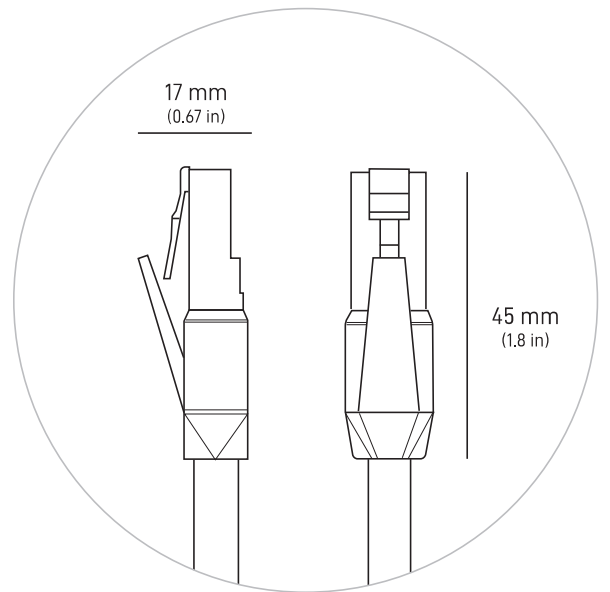
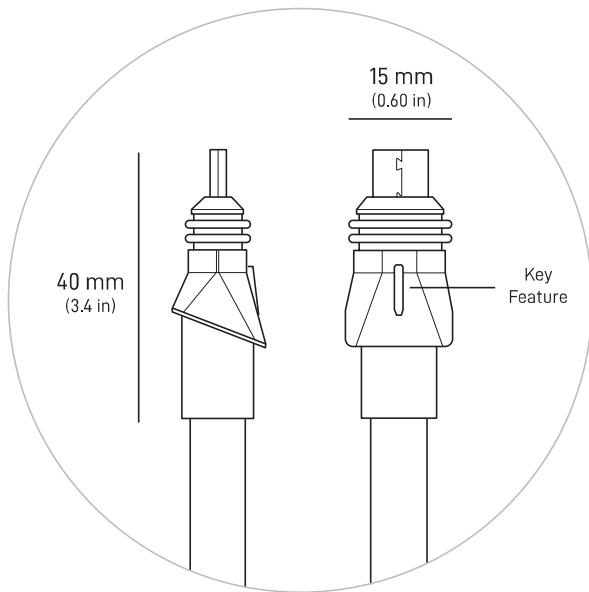
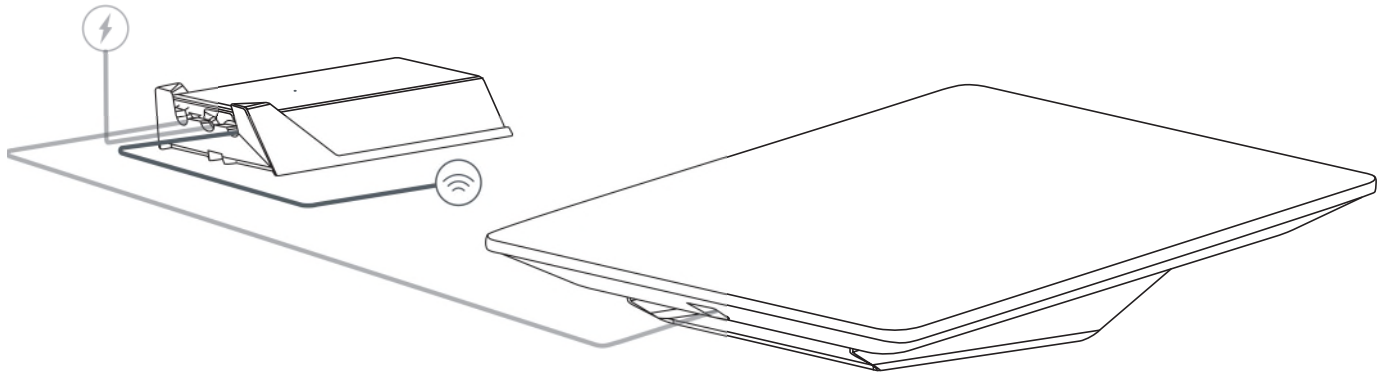

End	Pin	Ethernet Pin	Wire Color	Pin	End
RJ45	A1, A2	B+	Orange White	A1, A2	Power Supply
	A3, A4	B-	Orange	A3, A4	
	A5, A6	A+	Green White	A5, A6	
	A7, A8	A-	Green	A7, A8	
	B1, B2	--	N / C	B1, B2	
	B3, B4	--	N / C	B3, B4	
	B5	D+	Brown White	B5	
	B6	D-	Brown	B6	
	B7	C-	Blue White	B7	
	B8	C+	Blue	B8	
	B9, B10	--	N / C	B9, B10	
	B11, B12	--	N / C	B11, B12	
	Shield Can		Drain Wire	Shell	

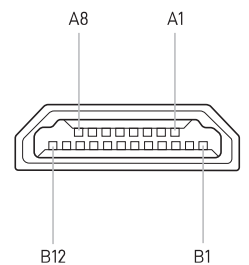

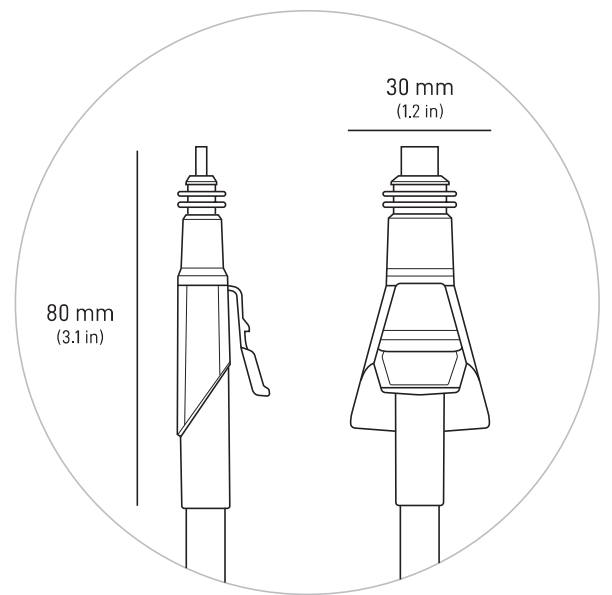
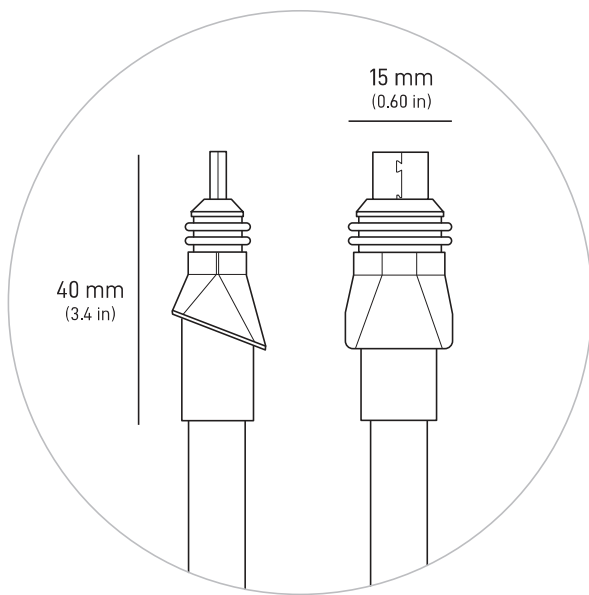
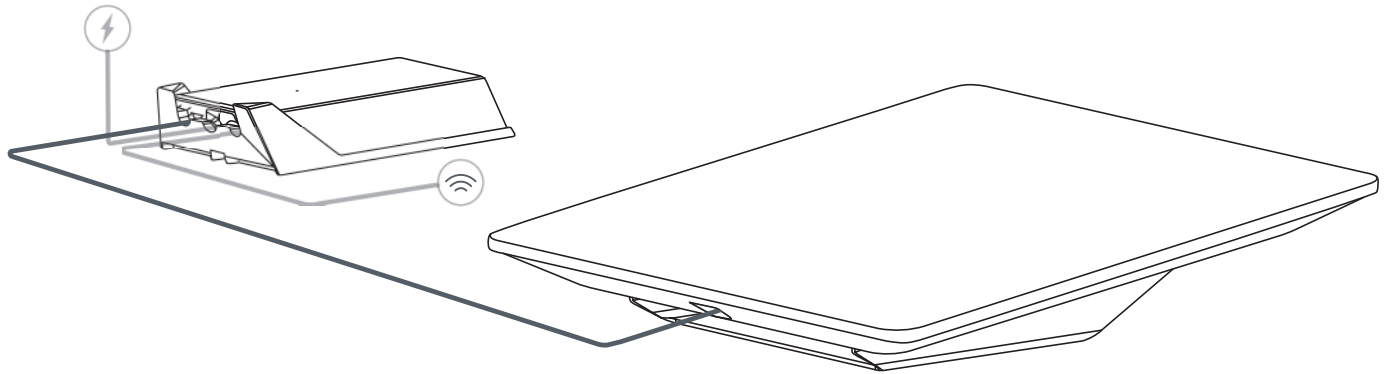

End	Pin	Wire Color	Pin	End
Dish	A1	Green	A1	Power Supply
	A2	Yellow	A2	
	A3	Blue	A3	
	A4	White	A4	
	B1	Orange	B1	
	B2	Purple	B2	
	B3	Brown	B3	
	B4	Gray	B4	
	B5	Shield / Shell	B5	

